

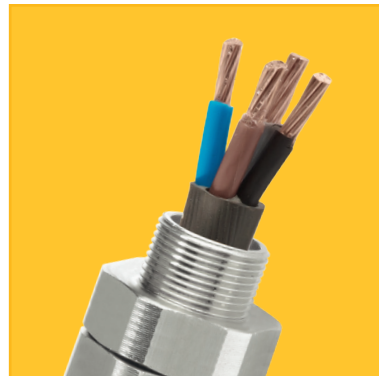

# CMP CABLE GLANDS & ACCESSORIES

AUSTRALIA & NEW ZEALAND PRODUCT CATALOGUE



## WHAT WE PROMISE FOR YOUR BUSINESS

CMP PRODUCTS IS A MARKET LEADING SPECIALIST DESIGNER, MANUFACTURER, AND SUPPLIER OF CABLE GLANDS, CABLE CLEATS AND ACCESSORIES.

Established as part of British Engines group in 1957, we have ensured that our customers remain at the heart of everything that we do, wherever they are around the world.

We believe in setting standards for quality and service, and leading the way in product innovation, whilst maintaining integrity, safety and reliability. This means that whether our products are used for onshore or offshore oil and gas installations, in power generation, transportation infrastructure, or for surface or underground mining applications, they always protect the safety of your people and your infrastructure.

By remaining focused on this commitment to our customers, our business has grown to become a world leader in our market, continuing to provide assurance of the highest standards of quality and service.

### INNOVATION IN PRODUCTS & SOLUTIONS

Evolving technical standards and stringent certification processes have helped to drive innovation at CMP. As a market leader in cable gland and cable cleat technology, we invest heavily in advanced manufacturing techniques, dedicated IT systems and effective training for our employees and customers.

The solutions chosen by our customers are often rigorously tested to perform above and beyond the normal standards, since they are used in progressively demanding applications and environments.

### PEOPLE & NETWORKS

CMP's structure allows us the flexibility to meet these continuously evolving needs, and we nurture this culture further by recruiting specialist, highly talented people in all areas of our business.

We have also formed excellent relationships with the people and organizations that do business with us, developing alliances with distributors and end-users internationally. This network is key to our strategy for bringing products to a worldwide market, via a strategic global distribution network reflective of our business.

### CUSTOMER CARE

Putting the customer at the centre of what we do and ensuring a positive experience for everyone we work with is a vital part of our vision.

## AN INTRODUCTION TO CABLE GLANDS & CLEATS

CABLE GLANDS ARE MECHANICAL CABLE ENTRY DEVICES USED TO TERMINATE CABLE, CABLE CLEATS RESTRAIN THE CABLE.

They are used throughout all industries in conjunction with cable and wiring used in electrical, instrumentation, control and automation systems.

Cable glands may be used on all types of electrical power, control, instrumentation, data and telecommunications cables and are used as sealing/terminating devices to ensure that the characteristics of the enclosure which the cable enters can be safely maintained. The main functions of the cable gland, depending on type, are listed briefly as follows:

- Provide environmental protection by sealing on the outer cable sheath, excluding dust and moisture from the electrical or instrument enclosure.
- In the case of armoured cables, facilitate ground continuity, when the cable gland has a metallic construction. In this case cable glands may be tested to ensure that they can withstand a minimum short circuit fault current, corresponding to that of the cable armour or peak fault of the electrical system.
- Provide a holding force on the cable to ensure adequate levels of cable pull-out resistance, and prevent lateral and axial loads being applied to the internal cable conductor terminations.
- Provide additional sealing on the part of the cable entering the enclosure, when a high degree of ingress protection is required.
- Provide additional environmental sealing at the cable entry point, maintaining the ingress protection rating of the enclosure and cable gland combination, with the selection of applicable accessories dedicated to performing this function.
- Constructed from corrosion-resistant materials determined by selection to a technical standard, or by corrosion resistance tests.

Cable cleats are devices designed and tested to ensure the retention and support of cables. CMP cable cleats are designed and 3<sup>rd</sup> party tested to IEC 61914 and are available for all industries including rail where securing low, medium or high voltage cables safely, is vital. By ensuring the cables are fixed, retained and supported correctly this protects all of the cable terminations by reducing the mechanical load exerted on them.

## WHY CHOOSE CMP PRODUCTS?

### QUALITY ASSURANCE & RELIABILITY

CMP PRODUCTS HAS AN INTERNATIONAL REPUTATION FOR QUALITY AND RELIABILITY AND IS HIGHLY REGARDED AS THE LEADING SPECIALIST IN THE DESIGN AND MANUFACTURE OF CABLE GLANDS AND ACCESSORIES FOR GENERAL PURPOSE AND HAZARDOUS LOCATIONS.

This position as market leader is maintained by listening to our customers and understanding their needs, to ensure that our solutions are practical to install and fully compliant with the latest industry standards and specifications.

In recognition of the need to demonstrate and maintain standards, CMP Products has attained approval as a 'quality assured' company, covering the design and manufacture of cable glands, cable cleats and associated accessories. Our Integrated management system is approved to ISO 9001:2015, ISO 14001:2015 and ISO45001:2018 with our 3<sup>rd</sup> party periodic audit and ongoing approval is performed by Bureau Veritas.

### RESEARCH & DEVELOPMENT

Research and development (R&D) is fundamental to the successful advances made with our product innovations and is a major contributor to helping customers achieve reciprocal success, whilst setting CMP apart from the rest of the market. R&D at CMP Products is powered by an engineering community of highly skilled technical experts in several locations around the world.

Such a comprehensive R&D team allows us to create bespoke solutions to meet the needs of our customers, which in turn can be thoroughly tested in our on-site certified laboratory and then third party certified if required.

### COMPLIANCE WITH CURRENT STANDARDS

CMP Products leads the way in the application of technical standards and with a dedicated certification team we design, manufacture and supply products that are compliant with all of the latest standards for NEC, CEC and IEC based installations.

### TECHNICAL SUPPORT & TRAINING

With several offices spread across six continents including Europe, the Americas, Australia, Asia and Africa we are able to satisfy the worldwide demand for comprehensive training in the installation of our products.

Attendees at all CMP training courses will receive a certificate of proficiency following successful completion. We also provide installation videos, as well as technical support and practical demonstrations at your premises or on-site.

### GLOBAL CERTIFICATION

CMP Products remains in constant touch with the development of national and international technical standards, and consequently is able to offer product solutions that are certified for multiple applications around the world. This entails a number of single off-the-shelf product solutions marked with Global Certification as standard.

INTERNATIONAL EXPLOSIVE ATMOSPHERES APPROVALS HELD INCLUDE cCSAus, CSA, UL, ATEX, IECEx, INMETRO, KCS, NEPSI, CIDET, CCOE / PESO, RETIE, EAC AND MARINE APPROVALS.

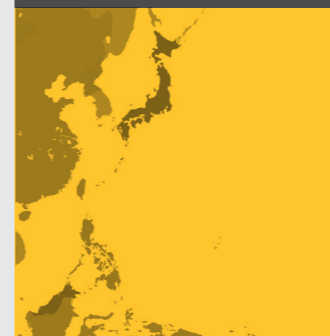

# INDUSTRIES & KEY FEATURES

## ABOVE GROUND MINING



### Open Cut / Processing

- Terminate all cables unarmoured, armoured, braid, copper tape
- Long thread glands suitable for thick gland plates
- Deluge protection limits corrosion in armour and superior IP rating

## UNDERGROUND MINING



### Coal Mining

- SIMTARS certified for Queensland market
- FRAS hose clamp glands - A2F100HC
- 100% pull test - Do not require immediate clamping
- Cable gland comprehensive package - glands, stopping plugs, reducers & adaptors

## RENEWABLES



### Solar & Wind Farms

- Nylon and metallic cable gland materials
- Superior EMC performance
- VO rated nylon glands
- High UV tested

## DEFENCE



### Land, Sea & Air

- Military standard testing
- Marine certification
- Superior impact, shock and deluge testing

## INFRASTRUCTURE



### Road & Rail Tunnels

- Nylon and metallic cable gland materials
- Low Smoke and Fume Zero Halogen (LSFOH)
- LUL - London Underground approval
- Long threaded glands - suitable for thick gland plates
- EMC tested

## OIL & GAS



### Upstream & Downstream

- Global certification and marking
- Metal-to-metal tightening for reliability
- Superior earth continuity
- RapidEx resin solution barrier glands
- Certified conduit accessories - reducers, adaptors, 90° adaptors

## POWER STATIONS & SUBSTATIONS



- Terminate all cables
- Long threaded glands - suitable for thick gland plates
- EMC tested

**CABLE CLEATS**

- Tested to IEC 61914
- Low Smoke and Fume Zero Halogen (LSFOH)
- London Underground
- Approved (LUL)
- Various materials: Nylon, Aluminium and 316L Stainless Steel
- All formations: Single, Trefoil and Quad
- Suitable for all industries
- Bespoke solutions

# CMP PRODUCTS CABLE GLANDS - THE KEY FEATURES

CMP has a wide range of cable glands available to suit different cables, environments and applications and it is imperative that the correct cable gland is selected for the correct scenario.

A typical CMP double seal cable gland is shown below and illustrates the complexity of engineering that goes into securing cables and infrastructure. This particular example would be typical of a cable gland used in an explosive atmosphere.

The range covers cable glands for standard industrial application through to explosive atmosphere cable glands which provide additional levels of protection.

## TYPICAL CMP DOUBLE SEAL CABLE GLAND

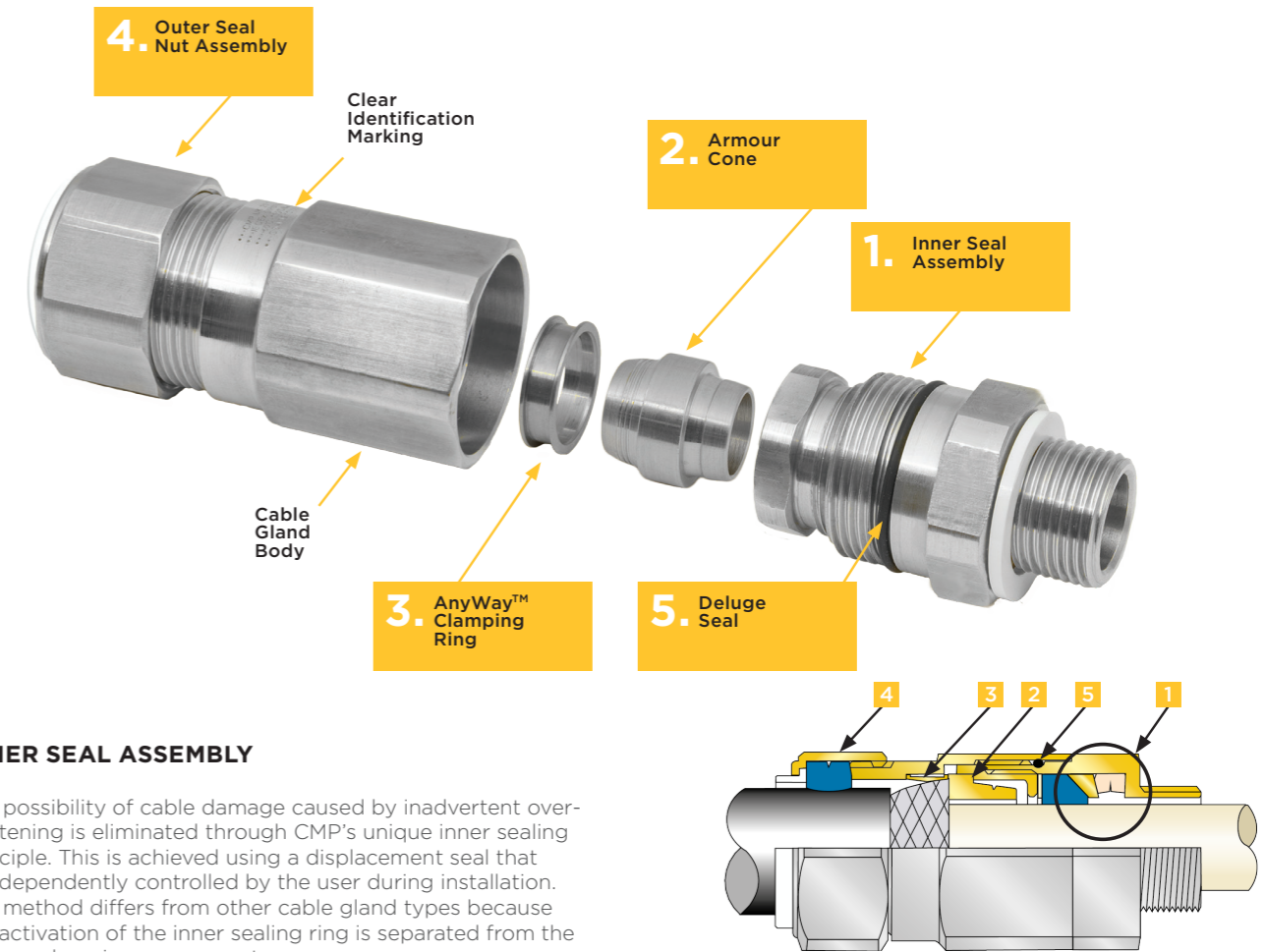

1.

### INNER SEAL ASSEMBLY

The possibility of cable damage caused by inadvertent over-tightening is eliminated through CMP's unique inner sealing principle. This is achieved using a displacement seal that is independently controlled by the user during installation. The method differs from other cable gland types because the activation of the inner sealing ring is separated from the armour clamping components.

The Compensating Displacement Seal System (1) has helped CMP to take its original displacement sealing ring concept to another level. The unique compensator has allowed the cable gland components to be fully tightened metal-to-metal and relieve the potential excess forces that could be transferred to the cable bedding, eliminating cable damage.

2/3.

### ARMOUR CONE AND ANYWAY™ CLAMPING RING

CMP Products' armour clamping method involves a unique termination solution that ensures a permanent crimping of the cable armour, creating a low impedance 360° connection that does not self-loosen. The patented AnyWay™ clamping ring aids an easy 'right-first-time' installation. Secure armour clamping like this also contributes to enhanced levels of EMC performance and creates reliable earth continuity.

2.

### INNER SEAL ASSEMBLY

The possibility of cable damage caused by inadvertent over-tightening is eliminated through CMP's unique inner sealing principle. This is achieved using a displacement seal that is independently controlled by the user during installation. The method differs from other cable gland types because the activation of the inner sealing ring is separated from the armour clamping components.

4.

### OUTER SEAL NUT ASSEMBLY

The unique CMP Outer Seal Tightening Guide (OSTG) and Load Retention Sealing Ring (LRS) ensure an IP/NEMA rated seal is formed against the cable to the correct degree. This is also applicable to our sealing rings on unarmoured cable glands.

5.

### DELUGE SEAL

CMP Products integrated 'O' ring deluge seal (tested to DTS 01:91) prevents corrosion of the cable armour by ensuring that moisture cannot track around the cable gland threads and into the armour termination body. As an internally enclosed deluge seal the 'O' ring is protected from mechanical damage and harmful UV rays.

# RAPIDEX THE FAST CURING, GAS BLOCKING, LIQUID RESIN SEAL



THE EFFECTIVE SEALING OF INSTRUMENT AND ELECTRICAL CABLES SHOULD NOT BE UNDERESTIMATED.

Traditional barrier type cable glands employing an epoxy-cured clay based sealing compound, have been used in the industry for many years, to provide effective explosion protection. However, a certain degree of skill is required with this traditional installation process and the risk of voids increases with the number of cable cores.

Multi-core cable requires the highest degree of competence and a lengthy installation time to ensure a void-free, safe installation. An inability to recognize this will lead to rework, or risk of failure of the seal.

RapidEx is a liquid pour, fast curing, liquid resin barrier seal that installs in seconds and cures in minutes.

Its unique formula begins with a low viscosity liquid that flows into the cable interstices completely surrounding the cable conductors, and in the process displacing the air from the cable gland's sealing chamber ensuring the 'perfect seal'.

- The viscosity increases and completely cures in less than 40 minutes (at 20°C)
- Enhances reliability, reduces risk
- Delivers unprecedented reliability
- Minimizes installation time
- Clean and easy to use

CMP RapidEx is certified for use in explosive atmospheres with global certification including approval under NEC, CEC and IEC installation codes, and is available with a series of CMP barrier cable glands and unions.

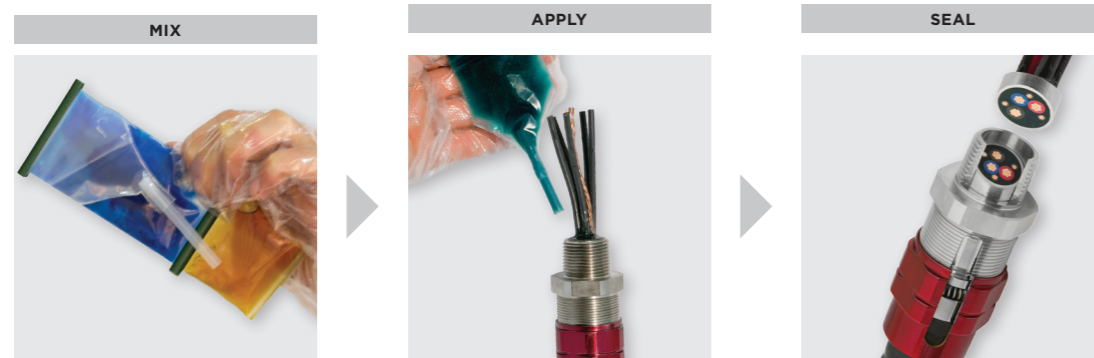

CABLE GLAND SIZE (**PX2KREX1RA5 & **PXSS2KREX1RA5)														
LINE 1	20S	20/ 20L	25	25S	32	40	50S	50	63S	63	75S	75	90	100
M20	1 x 30	1 x 30												
M25			1 x 30	1 x 30										
M32					1 x 30									
M40						1 x 30								
M50							1 x 80	1 x 80						
M63									2 x 80	2 x 80				
M75											2 x 80	2 x 80		
M90													2 x 80	
M100														3 x 80

The table above shows the quantity and volume (30cc or 80cc bag) of RapidEx resin required for each cable gland size.

PATENT GRANTED: ES 2287986, NO 2287986, TR 2287986, AU 2010284848, AU 2014274614, GB 2485114, SG 178839, US 8872027, US 9484133, US 9774178, MY 153846, US 10193321, US1034078

# MATERIAL AND THREAD SPECIFICATION

MATERIALS		
BRASS EXTRUSION*	BS EN 12164:2011 / BS EN 12168:2011	Grade: CuZn39Pb3 (CW614N)
STAINLESS STEEL EXTRUSION	EN 10088-3 : 2014	Grade: 316S11, 316S13, 316S3, 316S33, 316, 316L
ALUMINIUM EXTRUSION	BS EN 573-3:2013 / BS EN 755-1, -2, -3:2008	Grade: 6082 T6 OR 6262 T6
ALUMINIUM CASTINGS	BS EN 1706:2010 / BS EN 1676:2010	Grade: ENAC42000 / LM25TF
BRASS CASTINGS*	BS 1400 : 1985	Grade: GB/T 5231-2012 HPb58-3 / ASTM38000, JIS C3604

\* Brass products may be nickel plated to a maximum thickness of 0.008mm. Materials will contain less than: 7.5% magnesium, 7.5% titanium, 7.5% zirconium

THREAD CONSTRUCTION STANDARDS	
METRIC	ISO 965-1, ISO 965-3 medium fit (6g) for external threads, (6H) for internal threads
IMPERIAL CONDUIT (ET)	BS 31:1940 (1979) Table 'A' external threads, Table 'B' internal threads
PG	DIN 40430:1971
BSPP	BS2279:1986 class A full form threads
BSPT	BS2279:1986 standard threads only as clause 5.4, gauging to clause 5.2, system A
ISO	ISO 7/1:1994 gauging to ISO 7/2 clause 6.3 external threads, 6.2 internal threads
NPT	ANSI / ASME B1.20.1 - 2013 gauging to clause 3.2.1 for external threads, 3.2.2 for internal threads and IEC 60981
NPSM	ANSI / ASME B1.20.1 - 2013 gauging to clause 6.4

ISO METRIC IEC 60423									PG DIN 40430									
THREAD REFERENCE	16	20	25	32	40	50	63	75	90	THREAD REFERENCE	PG7	PG9	PG11	PG13.5	PG16	PG21	PG29	PG36
THREAD SIZE	M16	M20	M25	M32	M40	M50	M63	M75	M90	THREAD SIZE	PG7	PG9	PG11	PG13.5	PG16	PG21	PG29	PG36
THREAD PITCH	1.5	1.5	1.5	1.5	1.5	1.5	1.5	1.5	2.0	THREAD PITCH	1.27	1.41	1.41	1.41	1.41	1.59	1.59	1.59
THREAD PER INCH	16.93	16.93	16.93	16.93	16.93	16.93	16.93	16.93	12.7	THREAD PER INCH	20	18	18	18	18	16	16	16
MAJOR DIAMETER MAX	15.97	19.97	24.97	31.97	39.97	49.97	62.97	74.97	89.97	MAJOR DIAMETER MAX	12.5	15.2	18.6	20.4	22.5	28.3	37.0	47.0
RECOMMENDED CLEARANCE HOLE	16.5	20.5	25.5	32.5	40.5	50.5*	63.5*	75.5*	90.5	RECOMMENDED CLEARANCE HOLE	13.0	15.5	19.0	21.0	23.0	28.5	37.5	47.5

NPT ANSI B1.20.1									BSPP										
THREAD REFERENCE	050	075	100	125	150	200	250	300	THREAD REFERENCE	050	075	100	125	150	200	250	300		
THREAD SIZE	1/2"	3/4"	1"	1 1/4"	1 1/2"	2"	2 1/2"	3"	THREAD SIZE	1/2"	3/4"	1"	1 1/4"	1 1/2"	2"	2 1/2"	3"		
THREAD PITCH	1.81	1.81	2.2	2.2	2.2	2.2	3.18	3.18	THREAD PITCH	1.81	1.81	2.31	2.31	2.31	2.31	2.31	2.31		
THREAD PER INCH	14	14	11.5	11.5	11.5	11.5	8	8	THREAD PER INCH	14	14	11	11	11	11	11	11		
MAJOR DIAMETER MAX	METRIC	21.34	26.67	33.4	42.16	48.26	60.33	73.03	88.9	MAJOR DIAMETER MAX	METRIC	20.96	26.44	33.25	41.91	47.8	59.61	75.19	87.88
	IMPERIAL	0.84"	1.05"	1.32"	1.66"	1.90"	2.38"	2.88"	3.50"		IMPERIAL	0.83"	1.04"	1.31"	1.65"	1.88"	2.35"	2.96"	3.46"
RECOMMENDED CLEARANCE HOLE	METRIC	21.5	27.0	34.0	42.5	48.5	60.5*	73.5*	89.5*	RECOMMENDED CLEARANCE HOLE	METRIC	21.5	27.0	33.5	42.5	48.0	60.0	75.5*	88.5*
	IMPERIAL	5/16"	1-1/16"	1-1/8"	1-3/8"	1-7/16"	2-1/8"	2-7/16"	3-1/8"		IMPERIAL	7/32"	1-1/16"	1-5/16"	1-3/8"	1-7/16"	2-1/8"	2-3/8"	3-1/8"

NPSM ANSI B1.20.1									BSPT										
THREAD REFERENCE	050	075	100	125	150	200	250	300	THREAD REFERENCE	050	075	100	125	150	200	250	300		
THREAD SIZE	1/2"	3/4"	1"	1 1/4"	1 1/2"	2"	2 1/2"	3"	THREAD SIZE	1/2"	3/4"	1"	1 1/4"	1 1/2"	2"	2 1/2"	3"		
THREAD PITCH	1.81	1.81	2.2	2.2	2.2	2.2	3.18	3.18	THREAD PITCH	1.81	1.81	2.31	2.31	2.31	2.31	2.31	2.31		
THREAD PER INCH	14	14	11.5	11.5	11.5	11.5	8	8	THREAD PER INCH	14	14	11	11	11	11	11	11		
MAJOR DIAMETER MAX	METRIC	20.9	26.26	32.84	41.6	47.67	59.71	72.16	88.06	MAJOR DIAMETER MAX	METRIC	20.96	26.44	33.25	41.91	47.8	59.61	75.18	87.88
	IMPERIAL	0.82"	1.03"	1.29"	1.64"	1.88"	2.35"	2.84"	3.47"		IMPERIAL	0.83"	1.04"	1.31"	1.65"	1.88"	2.35"	2.96"	3.46"
RECOMMENDED CLEARANCE HOLE	METRIC	21.5	26.5	33.0	42.0	48.0	60.0	72.5*	88.5*	RECOMMENDED CLEARANCE HOLE	METRIC	21.5	27.0	33.5	42.5	48.0	60.0	75.5*	88.5*
	IMPERIAL	7/32"	1-3/16"	1-5/16"	1-7/16"	1-7/8"	2-3/8"	2-7/8"	3-1/8"		IMPERIAL	7/32"	1-1/16"	1-5/16"	1-3/8"	1-7/16"	2-1/8"	2-3/8"	3-1/8"

All dimensions in millimeters unless stated  
\*Non-standard drill size

# TSP

TRUSEAL TSP POLYMER,  
INDUSTRIAL CABLE GLAND

## FOR ALL TYPES OF UNARMoured CABLES

- Halogen and phosphorus-free
- Finger-locking seal provides superior cable retention and strain relief
- 3<sup>rd</sup> party certified to IEC/EN 62444
- Flame retardant UL94 V-0 version available
- Low weight with high stiffness and strength
- Widest cable range take for any comparable cable gland
- Available in a variety of colours (black as standard, see table below)
- Anti-vibration technology prevents seal loosening in operation
- Transit disc or IP68, IP69 and IP69K rated IP plug options available
- Box order quantity applies
- Approved entry thread sealing washer included
- Locknut supplied assembled

TRUSEAL  
POLYMER



shown in black with standard seal and locknut

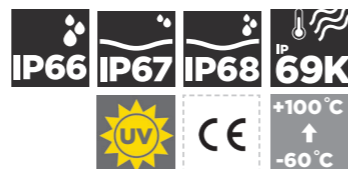

COLOUR	SUFFIX	METRIC ORDERING EXAMPLE
BLACK - RAL9011	-	12TSP2TNL/A
GREY - RAL7035	1	12TSP2TN1L/A
GREY - RAL7001	2	12TSP2TN2L/A
WHITE	3	12TSP2TN3L/A
BLUE - RAL5015	4	12TSP2TN4L/A
RED - RAL3000	5	12TSP2TN5L/A

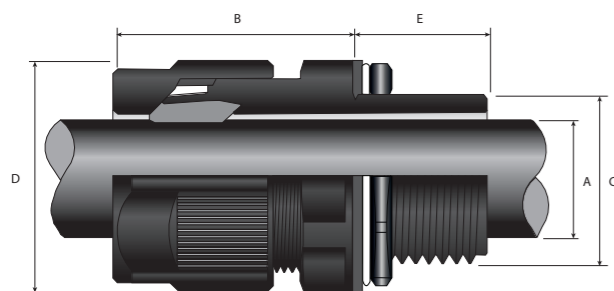

TECHNICAL DATA	
DESIGN SPECIFICATION	IEC 62444, EN 62444 (EN Metric only)
MECHANICAL CLASSIFICATION*	12-16 Impact = Level 4, 20-63 Impact = Level 6, Cable Anchorage = Type A
ENCLOSURE PROTECTION	12-16 IK07 to IEC 62262 (contact CMP for specific impact) 20-63 IK08 to IEC 62262 (7 joules)
INGRESS PROTECTION RATING	IP66, IP67, IP68**, IP69 & IP69K
CABLE GLAND MATERIAL	Halogen-free Polyamide
SEAL MATERIAL	CMP SOLO LSF Halogen-free Thermoset Elastomer
CABLE TYPE	Unarmoured & Braided (when braid is terminated inside enclosure)
SEALING TECHNIQUE	CMP Unique finger-locking type seal
SEALING AREA(S)	Cable Outer Sheath

\* Mechanical classifications applied as per IEC 62444 and EN 62444  
\*\* IP68 tested to 300 kPa for 16 hours (equivalent to 30 metres water depth)

## PRODUCT SELECTION TABLE WITH STANDARD SEALING RANGE

ORDERING REFERENCE WITH LOCKNUT	BOX QUANTITY	AVAILABLE ENTRY THREADS 'C'		OVERALL CABLE DIAMETER 'A'		ACROSS FLATS 'D'	ACROSS CORNERS 'D'	PROTRUSION LENGTH 'B'	SHROUD
		METRIC	LONG THREAD LENGTH (METRIC) 'E'	MIN	MAX				
12TSP2TNL/A	50	M12	15.0	3.0	6.5	15.0	16.4	27.0	-
16STSP2TNL/A	50	M16	15.0	3.0	7.0	19.0	20.9	27.0	PVC02
16TSP2TNL/A	50	M16	15.0	6.0	10.0	19.0	20.9	27.0	PVC02
20STSP2TNL/A	25	M20	15.0	5.0	10.0	24.0	26.2	30.5	PVC04
20TSP2TNL/A	25	M20	15.0	9.0	14.0	24.0	26.2	30.5	PVC04
25STSP2TNL/A	25	M25	15.0	9.0	15.5	30.0	32.7	36.0	PVC06
25TSP2TNL/A	25	M25	15.0	12.5	18.0	30.0	32.7	36.0	PVC06
32STSP2TNL/A	10	M32	15.0	12.5	19.0	40.0	43.6	41.0	PVC10
32TSP2TNL/A	10	M32	15.0	17.0	25.0	40.0	43.6	41.0	PVC10
40STSP2TNL/A	6	M40	18.0	19.0	27.0	50.0	54.5	49.0	PVC13
40TSP2TNL/A	6	M40	18.0	24.0	32.0	50.0	54.5	49.0	PVC13
50STSP2TNL/A	2	M50	18.0	22.0	32.0	58.0	63.2	59.0	PVC16
50TSP2TNL/A	2	M50	18.0	28.0	38.0	58.0	63.2	59.0	PVC16
63STSP2TNL/A	2	M63	18.0	28.0	39.0	68.0	74.1	64.0	PVC19
63TSP2TNL/A	2	M63	18.0	37.0	48.0	68.0	74.1	64.0	PVC19

Dimensions are displayed in millimetres unless otherwise stated

# TSPVO

TSPVO UL94 V-0 APPROVED,  
INDUSTRIAL CABLE GLAND

## FOR ALL TYPES OF UNARMoured CABLES

For use in the construction of public buildings including tower blocks, airports, hospitals, stadia, and for essential services including, fire safety systems, rail infrastructure, tunnels and ventilation systems, where halogen-free cables are required.

- Halogen and phosphorus-free
- Extremely flame retardant and self-extinguishing according to UL94 V-0
- Incorporates CMP's trusted SOLO technology
- 3<sup>rd</sup> party certified to IEC/EN 62444
- Finger-locking seal provides superior cable retention and strain relief
- Low weight with high stiffness and strength
- Widest cable range take for any comparable cable gland
- Approved entry thread sealing washer included
- Locknut supplied assembled

TRUSEAL SOLO  
POLYMER



shown in grey ral7035 with dual seal



TECHNICAL DATA	
DESIGN SPECIFICATION	IEC 62444, EN 62444 (EN Metric only)
MECHANICAL CLASSIFICATION*	High impact resistance, contact CMP
ENCLOSURE PROTECTION	High impact resistance, contact CMP
INGRESS PROTECTION RATING	IP66, IP67, IP68** & IP69K
FLAME RETARDANCY	Glow Wire Test - EN/IEC 60695-2: 960°C Flammability Test - EN/IEC 60695-11-10 / UL94: V-0
CABLE GLAND MATERIAL	UL94 V-0 Halogen and phosphorus-free flame retardant polyamide
SEAL MATERIAL	CMP SOLO LSF Halogen-free Thermoset Elastomer
CABLE TYPE	Unarmoured & Braided (when braid is terminated inside enclosure)
SEALING TECHNIQUE	CMP Unique finger-locking type seal
SEALING AREA(S)	Cable Outer Sheath

\* Mechanical Classifications applied as per IEC 62444 and EN 62444  
\*\* IP68 tested to 300 kPa for 16 hours (equivalent to 30 metres water depth)

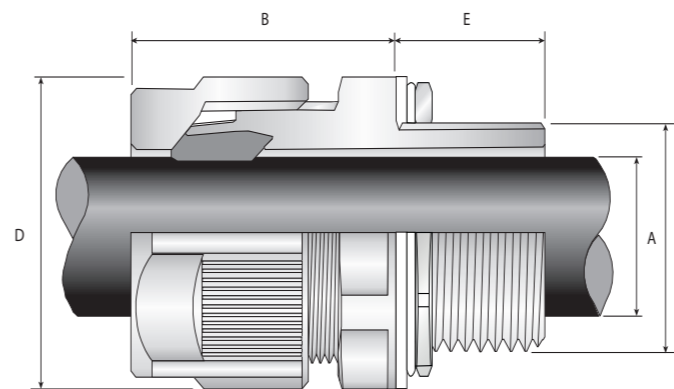

## PRODUCT SELECTION TABLE WITH STANDARD SEALING RANGE

ORDERING REFERENCE WITH LOCKNUT	AVAILABLE ENTRY THREADS 'C'		OVERALL CABLE DIAMETER 'A'		ACROSS FLATS 'D'	ACROSS CORNERS 'D'	PROTRUSION LENGTH 'B'	SHROUD
	METRIC	LONG THREAD LENGTH (METRIC) 'E'	MIN	MAX				
12TSPVO2TNIL	M12	15.0	3.0	6.5	15.0	16.4	27.0	-
16STSPVO2TNIL	M16	15.0	3.0	7.0	19.0	20.9	27.0	LSF02
16TSPVO2TNIL	M16	15.0	6.0	10.0	19.0	20.9	27.0	LSF02
20STSPVO2TNIL	M20	15.0	5.0	10.0	24.0	26.2	30.5	LSF04
20TSPVO2TNIL	M20	15.0	9.0	14.0	24.0	26.2	30.5	LSF04
25STSPVO2TNIL	M25	15.0	9.0	15.5	30.0	32.7	36.0	LSF06
25TSPVO2TNIL	M25	15.0	12.5	18.0	30.0	32.7	36.0	LSF06
32STSPVO2TNIL	M32	15.0	12.5	19.0	40.0	43.6	41.0	LSF10
32TSPVO2TNIL	M32	15.0	17.0	24.8	40.0	43.6	41.0	LSF10
40STSPVO2TNIL	M40	18.0	19.0	27.0	50.0	54.5	49.0	LSF13
40TSPVO2TNIL	M40	18.0	24.0	32.0	50.0	54.5	49.0	LSF13
50STSPVO2TNIL	M50	18.0	22.0	32.0	58.0	63.2	59.0	LSF16
50TSPVO2TNIL	M50	18.0	28.0	38.0	58.0	63.2	59.0	LSF16
63STSPVO2TNIL	M63	18.0	28.0	39.0	68.0	74.1	64.0	LSF19
63TSPVO2TNIL	M63	18.0	37.0	48.0	68.0	74.1	64.0	LSF19

Dimensions are displayed in millimetres unless otherwise stated

# TSPe Ex

**TRUSEAL TSPe Ex eb & Ex ta  
POLYMER, EXPLOSIVE ATMOSPHERE CABLE GLAND**

## FOR ALL TYPES OF UNARMoured CABLES

- Halogen and phosphorus-free
- Finger-locking seal provides superior cable retention and strain relief
- Approved to the latest editions of IEC/EN 60079
- Internationally marked IECEX and ATEX
- Intrinsically safe (Ex i) blue nut version available
- 3<sup>rd</sup> party certified to IEC/EN 62444
- Widest cable range take for any comparable cable gland
- Low weight with high stiffness and strength
- Anti-vibration technology prevents seal loosening in operation
- Transit disc or IP68, IP69 and IP69K rated IP plug options available
- Approved entry thread sealing washer included
- **For clearance holes the TSPe must be installed using a CMP metallic locknut**

**TRUSEAL**  
POLYMER



shown in black with standard seal



TECHNICAL DATA	
DESIGN SPECIFICATION	IEC 62444, EN 62444 (EN Metric only)
MECHANICAL CLASSIFICATION*	Size 16 Impact = Level 5, 20-63 Impact = Level 6, Cable Anchorage = Type A
ENCLOSURE PROTECTION	Size 16 IK07 to IEC 62262 (4 joules), 20-63 IK08 to IEC 62262 (7 joules)
INGRESS PROTECTION RATING	IP66, IP67, IP68** & IP69K
CABLE GLAND MATERIAL	Halogen-free Polyamide
SEAL MATERIAL	CMP SOLO LSF Halogen-free Thermoset Elastomer
CABLE TYPE	Unarmoured & Braided (when braid is terminated inside enclosure)
SEALING TECHNIQUE	CMP Unique finger-locking type seal
SEALING AREA(S)	Cable Outer Sheath

\* Mechanical Classifications applied as per IEC 62444 and EN 62444  
\*\* IP68 tested to 300 kPa for 16 hours (equivalent to 30 metres water depth)

GLOBAL PRODUCT CERTIFICATION			
ATEX CERTIFICATE	CML 19ATEX3185X	IECEX CERTIFICATE	IECEX CML 19.0062X
ATEX COMPLIANCE STANDARDS	EN 60079-0,7,31	IECEX COMPLIANCE STANDARDS	IEC 60079-0,7,31
CODE OF PROTECTION	Ⓜ II 2G ID, Ex eb IIC Gb, Ex ta IIIC Da	CODE OF PROTECTION	Ex eb IIC Gb, Ex ta IIIC Da
MARINE APPROVALS	DNV: TAE000000Y		

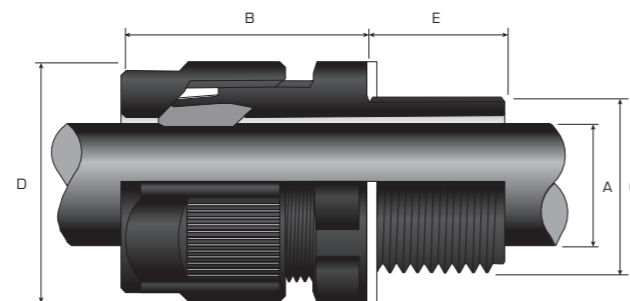

## PRODUCT SELECTION TABLE WITH DUAL SEALING RANGE

ORDERING REFERENCE WITHOUT LOCKNUT	AVAILABLE ENTRY THREADS 'C'		OVERALL CABLE DIAMETER 'A'		ACROSS FLATS 'D'	ACROSS CORNERS 'D'	PROTRUSION LENGTH 'B'
	METRIC	THREAD LENGTH (METRIC) 'E'	MIN	MAX	MAX	MAX	
16DTSPEITL	M16	15.0	3.2	10.0	19.0	20.9	27.0
20DTSPEITL	M20	15.0	5.5	14.0	24.0	26.2	30.5
25DTSPEITL	M25	15.0	9.0	18.0	30.0	32.7	36.0
32DTSPEITL	M32	15.0	12.5	25.0	40.0	43.6	41.0
40DTSPEITL	M40	18.0	19.0	32.0	50.0	54.5	49.0
50DTSPEITL	M50	18.0	22.0	38.0	58.0	63.2	59.0
63DTSPEITL	M63	18.0	28.0	48.0	68.0	74.1	64.0

Dimensions are displayed in millimetres unless otherwise stated

## PRODUCT SELECTION TABLE WITH STANDARD SEALING RANGE

ORDERING REFERENCE WITHOUT LOCKNUT	AVAILABLE ENTRY THREADS 'C'		OVERALL CABLE DIAMETER 'A'		ACROSS FLATS 'D'	ACROSS CORNERS 'D'	PROTRUSION LENGTH 'B'
	METRIC	THREAD LENGTH (METRIC) 'E'	MIN	MAX	MAX	MAX	
12TSPEITL	M12	15.0	3.0	6.5	15.0	16.4	27.0

Dimensions are displayed in millimetres unless otherwise stated

# TSPe Ex i

**TRUSEAL**  
POLYMER

**TRUSEAL TSPe Ex eb & Ex ta (TO BE USED WITH Ex i APPLICATIONS)  
POLYMER, EXPLOSIVE ATMOSPHERE CABLE GLAND**

## FOR ALL TYPES OF UNARMoured

- Blue nut for Intrinsically safe (Ex i) identification
- Halogen and phosphorus-free
- Finger-locking seal provides superior cable retention and strain relief
- Approved to the latest editions of IEC/EN 60079
- Internationally marked IECEX, ATEX and UKEX
- 3<sup>rd</sup> party certified to IEC/EN 62444
- Widest cable range take for any comparable cable gland
- Low weight with high stiffness and strength
- Anti-vibration technology prevents seal loosening in operation
- Transit disc or IP68, IP69 and IP69K rated IP plug options available
- Approved entry thread sealing washer included
- **For clearance holes the TSPe must be installed using a CMP metallic locknut**



shown with transit disc



TECHNICAL DATA	
DESIGN SPECIFICATION	IEC 62444, EN 62444 (EN Metric only)
MECHANICAL CLASSIFICATION*	12-16 Impact = Level 5, 20-63 Impact = Level 6, Cable Anchorage = Type A
ENCLOSURE PROTECTION	12-16 IK07 to IEC 62262 (4 joules), 20-63 IK08 to IEC 62262 (7 joules)
INGRESS PROTECTION RATING	IP66, IP67, IP68**, IP69 and IP69K
CABLE GLAND MATERIAL	Halogen-free Polyamide
SEAL MATERIAL	CMP SOLO LSF Halogen-free Thermoset Elastomer
CABLE TYPE	Unarmoured and Braided when terminated inside enclosure
SEALING TECHNIQUE	CMP Unique finger-locking type seal
SEALING AREA(S)	Cable Outer Sheath

\* Mechanical classifications applied as per IEC/EN 62444  
\*\* IP68 tested to 300 kPa for 16 hours (equivalent to 30 metres water depth)

GLOBAL PRODUCT CERTIFICATION			
ATEX CERTIFICATE	CML 19ATEX3185X	IECEX CERTIFICATE	IECEX CML 19.0062X
UKEX CERTIFICATE	CML 21UKEX3264X	CODE OF PROTECTION	Ex eb IIC Gb, Ex ta IIIC Da
CODE OF PROTECTION	Ⓜ II 2G ID, Ex eb IIC Gb, Ex ta IIIC Da	COMPLIANCE STANDARDS	IEC 60079-0,7,31
COMPLIANCE STANDARDS	EN 60079-0,7,31	COMPLIANCE STANDARDS	IEC 60079-0,7,31
EAC CERTIFICATE	RU C-GB.A.07.B.02516/20	DNV CERTIFICATE	TAE000000Y
SANS	IA S-XPL21804 21.0014X	CCC CERTIFICATE	2020322313003450

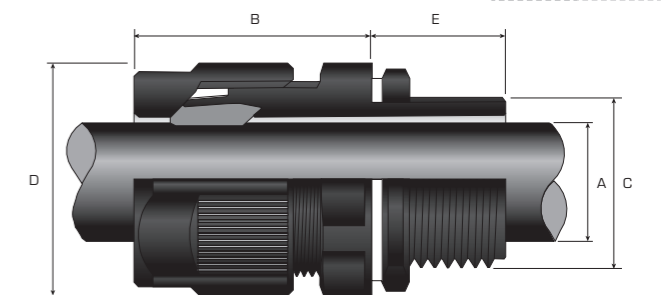

## PRODUCT SELECTION TABLE WITH DUAL SEALING RANGE

ORDERING REFERENCE WITHOUT LOCKNUT	AVAILABLE ENTRY THREADS 'C'		OVERALL CABLE DIAMETER 'A'		ACROSS FLATS 'D'	ACROSS CORNERS 'D'	PROTRUSION LENGTH 'B'
	METRIC	THREAD LENGTH (METRIC) 'E'	MIN	MAX	MAX	MAX	
16DTSPEITA4L	M16	15.0	3.2	10.0	19.0	20.9	27.0
20DTSPEITA4L	M20	15.0	5.5	14.0	24.0	26.2	30.5
25DTSPEITA4L	M25	15.0	9.0	18.0	30.0	32.7	36.0
32DTSPEITA4L	M32	15.0	12.5	25.0	40.0	43.6	41.0
40DTSPEITA4L	M40	18.0	19.0	32.0	50.0	54.5	49.0
50DTSPEITA4L	M50	18.0	22.0	38.0	58.0	63.2	59.0
63DTSPEITA4L	M63	18.0	28.0	48.0	68.0	74.1	64.0

Dimensions are displayed in millimetres unless otherwise stated

## PRODUCT SELECTION TABLE WITH STANDARD SEALING RANGE

ORDERING REFERENCE WITHOUT LOCKNUT	AVAILABLE ENTRY THREADS 'C'		OVERALL CABLE DIAMETER 'A'		ACROSS FLATS 'D'	ACROSS CORNERS 'D'	PROTRUSION LENGTH 'B'
	METRIC	THREAD LENGTH (METRIC) 'E'	MIN	MAX	MAX	MAX	
12TSPEITA4L	M12	15.0	3.0	6.5	15.0	16.4	27.0

Dimensions are displayed in millimetres unless otherwise stated

## TRUSEAL TSM INDUSTRIAL, METALLIC CABLE GLAND

### FOR ALL TYPES OF UNARMoured CABLE

- Finger-locking seal provides superior cable retention and strain relief
- 3<sup>rd</sup> party certified to IEC/EN 62444
- Widest cable range take for any comparable cable gland
- Easy to install
- Robust design, high quality materials
- O-ring interface seal included as standard
- Transit disc or IP68, IP69 and IP69K rated IP plug options available
- Product supplied in nickel-plated brass, or stainless steel on request
- Locknut supplied assembled



shown with standard seal

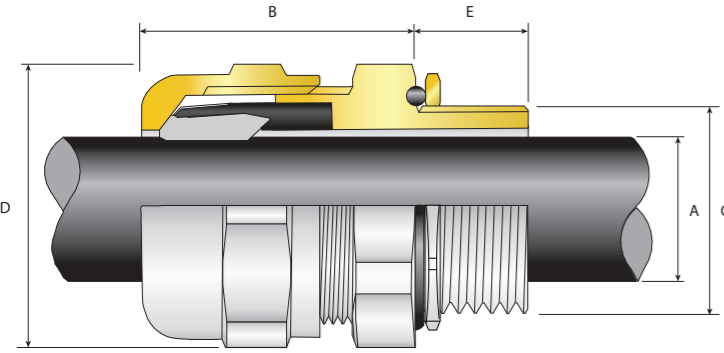
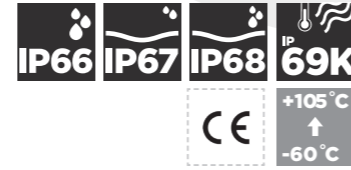

TECHNICAL DATA	
DESIGN SPECIFICATION	IEC 62444, EN 62444 (EN Metric only)
MECHANICAL CLASSIFICATION*	Impact = Level 6, Cable Anchorage = Type A
ENCLOSURE PROTECTION	IK08 to IEC 62262 (7 joules)
INGRESS PROTECTION RATING	IP66, IP67, IP68**, IP69 & IP69K
CABLE GLAND MATERIAL	Nickel Plated Brass
SEAL MATERIAL	CMP SOLO LSF Halogen Free Thermoset Elastomer
CABLE TYPE	Unarmoured and Braided (Braid terminated inside enclosure)
SEALING TECHNIQUE	CMP Unique finger-locking type seal
SEALING AREA(S)	Cable Outer Sheath

\* Mechanical Classifications applied as per IEC 62444 and EN 62444  
 \*\* IP68 tested to 300 kPa for 16 hours (equivalent to 30 metres water depth)

### PRODUCT SELECTION TABLE WITH STANDARD SEALING RANGE

ORDERING REFERENCE WITH LOCKNUT	AVAILABLE ENTRY THREADS 'C'		OVERALL CABLE DIAMETER 'A'		ACROSS FLATS 'D'	ACROSS CORNERS 'D'	SHROUD	PROTRUSION LENGTH 'B'
	METRIC	LONG THREAD LENGTH (METRIC) 'E'	MIN	MAX				
12TSM2TNSL/A	M12	12.0	3.0	6.5	16.0	17.6	-	22.3
16TSM2TNSL/A	M16	12.0	3.0	7.0	20.0	22.0	PVC02	23.6
16TSM2TNSL/A	M16	12.0	6.0	10.0	20.0	22.0	PVC02	23.6
20TSM2TNSL/A	M20	12.0	5.0	10.0	24.0	26.4	PVC04	26.7
20TSM2TNSL/A	M20	12.0	9.0	14.0	24.0	26.4	PVC04	26.7
25TSM2TNSL/A	M25	12.0	9.0	15.5	30.0	33.0	PVC06	32.0
25TSM2TNSL/A	M25	12.0	12.5	18.0	30.0	33.0	PVC06	32.0
32TSM2TNSL/A	M32	12.0	12.5	19.0	39.0	42.9	PVC10	37.8
32TSM2TNSL/A	M32	12.0	17.0	25.0	39.0	42.9	PVC10	37.8
40TSM2TNSL/A	M40	15.0	19.0	27.0	50.0	55.0	PVC13	44.7
40TSM2TNSL/A	M40	15.0	24.0	32.0	50.0	55.0	PVC13	44.7
50TSM2TNSL/A	M50	15.0	22.0	32.0	57.0	62.7	PVC16	48.7
50TSM2TNSL/A	M50	15.0	28.0	38.0	57.0	62.7	PVC16	48.7
63TSM2TNSL/A	M63	15.0	28.0	39.0	68.0	74.8	PVC19	52.2
63TSM2TNSL/A	M63	15.0	37.0	48.0	68.0	74.8	PVC19	52.2

Dimensions are displayed in millimetres unless otherwise stated

## TRUSEAL TSZ, EMC, INDUSTRIAL CABLE GLAND

### FOR ALL TYPES OF COPPER TAPE & BRAIDED EMC CABLES

- Designed for superior EMC performance
- 360° contact around screen circumference
- 3<sup>rd</sup> party EMC performance tested to EN 55032
- Finger-locking seal provides superior cable retention and strain relief
- 3<sup>rd</sup> party certified to IEC/EN 62444
- Widest cable range take on the market
- Robust design, high quality materials
- O-ring interface seal included as standard
- Transit disc or IP68, IP69 and IP69K rated IP plug options available
- Product supplied in nickel-plated brass, or stainless steel on request
- Ex eb certified product also available
- EMC or standard locknut sold separately

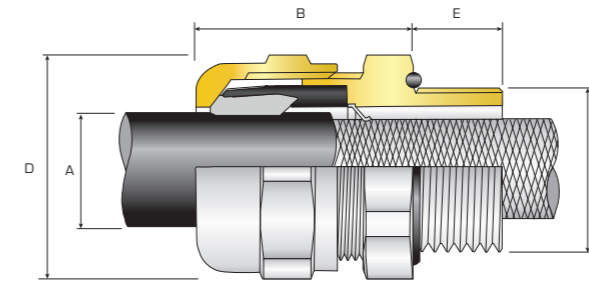

TECHNICAL DATA	
DESIGN SPECIFICATION	IEC 62444, EN 62444 (EN Metric only)
MECHANICAL CLASSIFICATION*	Impact = Level 6, Cable Anchorage = Type A
ENCLOSURE PROTECTION	IK08 to IEC 62262 (7 joules)
INGRESS PROTECTION RATING	IP66, IP67, IP68**, IP69 and IP69K
CABLE GLAND MATERIAL	Nickel-plated brass, Stainless Steel (option)
SEAL MATERIAL	CMP SOLO LSF Halogen-free Thermoset Elastomer
CABLE TYPE	Screened or Braided
SEALING TECHNIQUE	CMP Unique finger-locking type seal
SEALING AREA(S)	Cable Outer Sheath

\* Mechanical classifications applied as per IEC/EN 62444  
 \*\* IP68 tested to 300 kPa for 16 hours (equivalent to 30 metres water depth)

### PRODUCT SELECTION TABLE WITH DUAL SEALING RANGE

DUAL SEAL	AVAILABLE ENTRY THREADS 'C'		OVERALL CABLE DIAMETER 'A'		ACROSS FLATS 'D'	ACROSS CORNERS 'D'	PROTRUSION LENGTH 'B'	SHROUD
	METRIC	LONG THREAD LENGTH (METRIC) 'E'	MIN	MAX				
16DTSZITA5L	M16	12.0	3.0	10.0	20.0	22.0	23.6	PVC02
20DTSZITA5L	M20	12.0	5.0	14.0	24.0	26.4	26.7	PVC04
25DTSZITA5L	M25	12.0	9.0	18.0	30.0	33.0	32.0	PVC06
32DTSZITA5L	M32	12.0	12.5	25.0	39.0	42.9	37.8	PVC10
40DTSZITA5L	M40	15.0	19.0	32.0	50.0	55.0	44.7	PVC13
50DTSZITA5L	M50	15.0	22.0	38.0	57.0	62.7	48.7	PVC16
63DTSZITA5L	M63	15.0	28.0	48.0	68.0	74.8	52.2	PVC19

### PRODUCT SELECTION TABLE WITH STANDARD SEALING RANGE

STANDARD SEAL	AVAILABLE ENTRY THREADS 'C'		OVERALL CABLE DIAMETER 'A'		ACROSS FLATS 'D'	ACROSS CORNERS 'D'	PROTRUSION LENGTH 'B'	SHROUD
	METRIC	LONG THREAD LENGTH (METRIC) 'E'	MIN	MAX				
12TSZITA5L	M12	12.0	3.0	6.5	16.0	17.6	22.3	-

Dimensions are displayed in millimetres unless otherwise stated

# TSZe EMC Ex

**TRUSEAL**  
EMC

## TRUSEAL TSZe EMC Ex eb & Ex ta METALLIC, EXPLOSIVE ATMOSPHERE CABLE GLAND

### FOR ALL TYPES OF COPPER TAPE & BRAIDED EMC CABLES

- Designed for superior EMC performance
- 360° contact around screen circumference
- 3<sup>rd</sup> party EMC performance tested to EN 55032
- Approved to the latest editions of IEC/EN 60079
- Internationally marked IECEx, ATEX and UKEX
- Suitable for intrinsically safe (Ex i) circuits
- Finger-locking seal provides superior cable retention and strain relief
- 3<sup>rd</sup> party certified to IEC/EN 62444
- Widest cable range take on the market
- O-ring interface seal included as standard
- Transit disc or IP68, IP69 and IP69K rated IP plug options available
- Product supplied in nickel-plated brass, or stainless steel on request
- EMC or standard locknut sold separately



TECHNICAL DATA	
DESIGN SPECIFICATION	IEC 62444, EN 62444 (EN Metric only)
MECHANICAL CLASSIFICATION*	Impact = Level 6, Cable Anchorage = Type A
ENCLOSURE PROTECTION	IK08 to IEC 62262 (7 joules)
INGRESS PROTECTION RATING	IP66, IP67, IP68**, IP69 and IP69K
CABLE GLAND MATERIAL	Nickel-plated brass, Stainless Steel (option)
SEAL MATERIAL	CMP SOLO LSF Halogen-free Thermoset Elastomer
CABLE TYPE	Screened or Braided
SEALING TECHNIQUE	CMP Unique finger-locking type seal
SEALING AREA(S)	Cable Outer Sheath

GLOBAL PRODUCT CERTIFICATION			
ATEX CERTIFICATE	CML 19ATEX3185X	IECEx CERTIFICATE	IECEx CML 19.0062X
UKEX CERTIFICATE	CML 21UKEX3264X	CODE OF PROTECTION	Ex eb IIC Gb, Ex ta IIIC Da
CODE OF PROTECTION	Ⓜ II 2G 1D, Ex eb IIC Gb, Ex ta IIIC Da	COMPLIANCE STANDARDS	EN 60079-0,7,31
COMPLIANCE STANDARDS	EN 60079-0,7,31	COMPLIANCE STANDARDS	IEC 60079-0,7,31
EAC CERTIFICATE	RU C-GB.AJ07.B.02516/20	DNV CERTIFICATE	TAE00000Y
SANS	IA S-XPL21804 21.0014X	CCC CERTIFICATE	2020322313003450

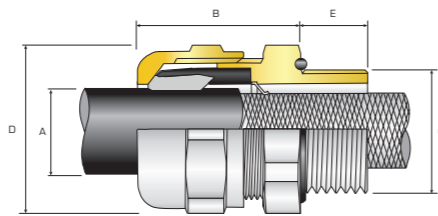

\* Mechanical classifications applied as per IEC/EN 62444  
\*\* IP68 tested to 300 kPa for 16 hours (equivalent to 30 metres water depth)

### PRODUCT SELECTION TABLE WITH DUAL SEALING RANGE

DUAL SEAL	AVAILABLE ENTRY THREADS 'C'		OVERALL CABLE DIAMETER 'A'		ACROSS FLATS 'D'	ACROSS CORNERS 'D'	PROTRUSION LENGTH 'B'	SHROUD
	METRIC	LONG THREAD LENGTH (METRIC) 'E'	MIN	MAX				
16DTSZEITA5L	M16	12.0	3.0	10.0	20.0	22.0	23.6	PVC02
20DTSZEITA5L	M20	12.0	5.0	14.0	24.0	26.4	26.7	PVC04
25DTSZEITA5L	M25	12.0	9.0	18.0	30.0	33.0	32.0	PVC06
32DTSZEITA5L	M32	12.0	12.5	25.0	39.0	42.9	37.8	PVC10
40DTSZEITA5L	M40	15.0	19.0	32.0	50.0	55.0	44.7	PVC13
50DTSZEITA5L	M50	15.0	22.0	38.0	57.0	62.7	48.7	PVC16
63DTSZEITA5L	M63	15.0	28.0	48.0	68.0	74.8	52.2	PVC19

### PRODUCT SELECTION TABLE WITH STANDARD SEALING RANGE

STANDARD SEAL	AVAILABLE ENTRY THREADS 'C'		OVERALL CABLE DIAMETER 'A'		ACROSS FLATS 'D'	ACROSS CORNERS 'D'	PROTRUSION LENGTH 'B'	SHROUD
	METRIC	LONG THREAD LENGTH (METRIC) 'E'	MIN	MAX				
12TSZEITA5L	M12	12.0	3.0	6.5	16.0	17.6	22.3	-

Dimensions are displayed in millimetres unless otherwise stated

# TMC

## TMC INDUSTRIAL HEAVY DUTY CABLE GLAND

### FOR VARIABLE SPEED DRIVE (VSD) UNARMoured CABLES WITH COPPER TAPE SCREEN

- Standard material nickel plated brass
- High quality durable materials
- Robust, heavy duty design
- Simple, sequential installation process
- Integral protected deluge seal
- Low Impedance Copper Plated Stainless Steel 360° Grounding Spring
- EMC tested
- 60°C to +130°C

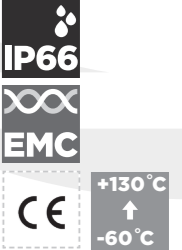

TECHNICAL CLASSIFICATION	
DESIGN SPECIFICATION	BS 6121:Part 1:1989, IEC 62444, EN 62444
MECHANICAL CLASSIFICATION*	Impact = Level 8, Cable Anchorage = Class D
ENCLOSURE PROTECTION	IK10 to IEC 62262 (20 joules) Brass & Stainless Steel only
INGRESS PROTECTION RATING**	IP66**
CABLE GLAND MATERIAL	Electroless Nickel Plated Brass (standard), Stainless Steel, Aluminium
SEAL MATERIAL	CMP SOLO LSF Halogen Free Thermoset Elastomer
CABLE TYPE	Screened, Tape Armour, including Variable Speed Drive Cables (VSD) with Copper Tape Screen
SEALING TECHNIQUE	CMP Load Retention Seal
SEALING AREA(S)	Cable Outer Jacket

\* Mechanical and Electrical Classifications applied as per IEC 62444 and EN 62444 \*\* When CMP installation accessories are used. Refer to www.cmp-products.com for further information.

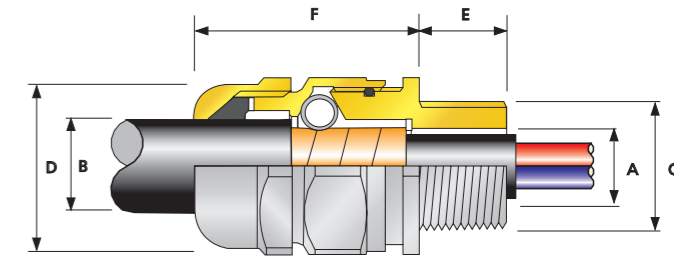

ORDERING REFERENCE	ENTRY THREAD 'C'	MINIMUM THREAD LENGTH 'E'	CABLE ARMOR DIAMETER 'A'				OVERALL CABLE DIAMETER 'B'		PROTRUSION LENGTH 'F'	MAX		SHROUD	WEIGHT (kg)
			END STOP IN		END STOP OUT		MIN	MAX		ACROSS FLATS 'D'	ACROSS CORNERS 'D'		
			MIN	MAX	MIN	MAX							
CMPTMC050SNB1AA5	M20	15.0	No Stop	No Stop	8.6	12.7	8.9	14.0	46.5	30.5	33.6	PVC06	0.147
CMPTMC050NB1AA5	M20	15.0	No Stop	No Stop	11.1	17.0	13.0	20.1	52.3	36.0	39.6	PVC09	0.224
CMPTMC075NB1AA5	M25	15.0	15.0	19.3	19.3	23.4	17.0	26.4	53.1	41.0	45.1	PVC10	0.221
CMPTMC100NB1AA5	M32	15.0	19.8	24.6	24.6	29.2	22.0	32.3	56.9	50.0	55.0	PVC13	0.306
CMPTMC125NB1AA5	M40	15.0	27.4	31.2	31.2	35.3	29.5	38.1	56.4	55.0	60.5	PVC15	0.448
CMPTMC150NB1AA5	M50	15.0	33.5	37.1	37.1	41.1	35.6	44.2	58.7	60.0	66.0	PVC18	0.567
CMPTMC200SNB1AA5	M50	15.0	38.3	42.6	42.7	47.0	40.1	50.0	64.0	70.0	77.0	PVC21	0.751
CMPTMC200NB1AA5	M63	15.0	45.0	49.0	49.0	53.1	47.2	56.1	63.2	75.0	82.5	PVC23	1.036
CMPTMC250SNB1AA5	M63	15.0	52.1	54.9	54.9	58.9	52.8	62.0	69.3	80.0	88.0	PVC25	1.016
CMPTMC250NB1AA5	M75	15.0	57.1	61.2	61.2	64.8	59.2	68.1	72.1	85.0	93.5	PVC27	1.787
CMPTMC300NB1AA5	M90	15.0	64.5	70.6	70.6	75.4	66.5	79.5	98.3	110.0	121.0	PVC31	2.091
CMPTMC350NB1AA5	M100	24.1	73.9	83.6	83.6	88.6	75.9	97.3	117.6	133.4	146.7	LSF34	3.044
CMPTMC400NB1AA5	M115	24.1	73.9	83.6	83.6	88.6	75.9	97.3	117.6	133.4	146.7	LSF34	3.132

Dimensions are displayed in millimetres unless otherwise stated



# A2

## A2 SINGLE SEAL INDUSTRIAL CABLE GLAND

### FOR ALL TYPES OF UNARMoured CABLE

- High quality durable materials
- Robust, heavy duty design
- Displacement type seal
- Deluge protected
- -60°C to +130°C (standard), -60°C to +180°C (ThermEx option)
- Entry thread sealing washer and locknut included as standard

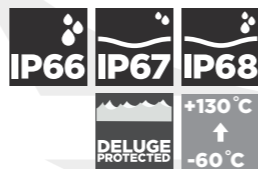
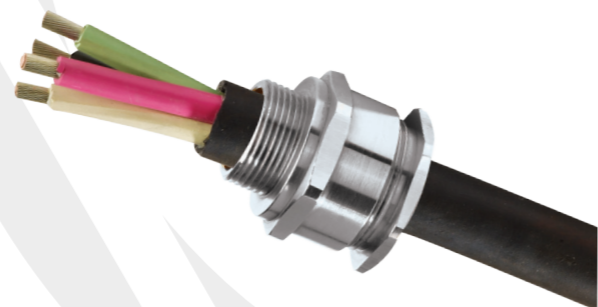

TECHNICAL CLASSIFICATION	
DESIGN SPECIFICATION	BS 6121: Part 1:1989, IEC 62444, EN 62444
MECHANICAL CLASSIFICATION*	Impact = Level 8, Cable Anchorage = Class B
ENCLOSURE PROTECTION	IK10 to IEC 62262 (20 joules) Brass & Stainless Steel only
INGRESS PROTECTION RATING**	IP66, IP67 & IP68***
DELUGE PROTECTION COMPLIANCE	DTS01: 91
CABLE GLAND MATERIAL	Electroless Nickel Plated Brass
SEAL MATERIAL	CMP Thermoset Rubber
CABLE TYPE	Unarmoured & Braided (Braid terminated inside enclosure)
SEALING TECHNIQUE	CMP Displacement Seal
SEALING AREA(S)	Cable Outer Sheath

\* Mechanical and Electrical Classifications applied as per IEC 62444 and EN 62444  
 \*\* When CMP installation accessories are used. Refer to www.cmp-products.com for further information. \*\*\* IP68 tested to a minimum depth of 30 metres for 12 hours, alternative depths / durations can be provided upon request

GLOBAL PRODUCT CERTIFICATION	
CSA CERTIFICATE	1211841
CSA CODE OF PROTECTION	Enclosure Type 4X
GOST R CERTIFICATE	POCC GB.HA46.H00140
MARINE APPROVALS	LRS: 01/00171, ABS: 16-LD1472056-PDA

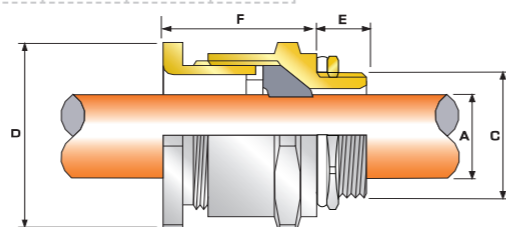

COMBINED ORDERING REFERENCE			AVAILABLE ENTRY THREADS 'C'		OVERALL CABLE DIAMETER 'A'		ACROSS FLATS 'D'	ACROSS CORNERS 'D'	PROTRUSION LENGTH 'F'	SHROUD	CABLE GLAND WEIGHT (kg)
SIZE	TYPE	ORDERING SUFFIX	METRIC	THREAD LENGTH 'E'	MIN	MAX	MAX	MAX			
16	A2	1RA5/A	M16	10.0	3.2	8.7	24.0	26.4	26.9	PVC04	0.070
20S16	A2	1RA5/A	M20	10.0	3.2	8.7	24.0	26.4	26.0	PVC04	0.070
20S	A2	1RA5/A	M20	10.0	6.1	11.7	24.0	26.4	26.0	PVC04	0.060
20	A2	1RA5/A	M20	10.0	6.5	14.0	27.0	29.7	27.7	PVC05	0.070
25	A2	1RA5/A	M25	10.0	11.1	20.0	36.0	39.6	35.5	PVC09	0.130
32	A2	1RA5/A	M32	10.0	17.0	26.3	41.0	45.1	35.1	PVC10	0.150
40	A2	1RA5/A	M40	15.0	23.5	32.2	50.0	55.0	35.1	PVC13	0.200
50S	A2	1RA5/A	M50	15.0	31.0	38.2	55.0	60.5	33.0	PVC15	0.260
50	A2	1RA5/A	M50	15.0	35.6	44.0	60.0	66.0	37.3	PVC18	0.270
63S	A2	1RA5/A	M63	15.0	41.5	49.9	70.5	77.6	33.5	PVC21	0.430
63	A2	1RA5/A	M63	15.0	47.2	55.9	75.0	82.5	36.2	PVC23	0.460
75S	A2	1RA5/A	M75	15.0	54.0	61.9	84.0	92.4	34.1	PVC24	0.520
75	A2	1RA5/A	M75	15.0	61.1	67.9	84.0	92.4	40.9	PVC24	0.500
90	A2	1RA5/A	M90	24.0	66.6	79.9	108.0	118.8	60.3	PVC31	1.600
100	A2	1RA5/A	M100	24.0	76.0	91.0	123.0	135.3	57.2	LSF33	1.780
115	A2	1RA5/A	M115	24.0	86.0	97.9	133.4	146.7	67.3	LSF34	2.670
130	A2	1RA5/A	M130	24.0	97.0	114.9	152.4	164.6	74.7	LSF35	3.800

Dimensions are displayed in millimetres unless otherwise stated

### 20MM LONG THREAD OPTION

COMBINED ORDERING REFERENCE			AVAILABLE ENTRY THREADS 'C'		OVERALL CABLE DIAMETER 'A'		ACROSS FLATS 'D'	ACROSS CORNERS 'D'	PROTRUSION LENGTH 'F'	SHROUD	CABLE GLAND WEIGHT (kg)
SIZE	TYPE	ORDERING SUFFIX	METRIC	THREAD LENGTH 'E'	MIN	MAX	MAX	MAX			
20S16	A2	1RA5/A20LOE	M20	20.0	3.2	8.7	24.0	26.4	26.0	PVC04	0.072
20S	A2	1RA5/A20LOE	M20	20.0	6.1	11.7	24.0	26.4	26.0	PVC04	0.062
20	A2	1RA5/A20LOE	M20	20.0	6.5	14.0	27.0	29.7	27.7	PVC05	0.072
25	A2	1RA5/A20LOE	M25	20.0	11.1	20.0	36.0	39.6	35.5	PVC09	0.132
32	A2	1RA5/A20LOE	M32	20.0	17.0	26.3	41.0	45.1	35.1	PVC10	0.152
40	A2	1RA5/A20LOE	M40	20.0	23.5	32.2	50.0	55.0	35.1	PVC13	0.202
50S	A2	1RA5/A20LOE	M50	20.0	31.0	38.2	55.0	60.5	33.0	PVC15	0.262
50	A2	1RA5/A20LOE	M50	20.0	35.6	44.0	60.0	66.0	37.3	PVC18	0.272
63S	A2	1RA5/A20LOE	M63	20.0	41.5	49.9	70.5	77.6	33.5	PVC21	0.432
63	A2	1RA5/A20LOE	M63	20.0	47.2	55.9	75.0	82.5	36.2	PVC23	0.462
75S	A2	1RA5/A20LOE	M75	20.0	54.0	61.9	84.0	92.4	34.1	PVC24	0.522
75	A2	1RA5/A20LOE	M75	20.0	61.1	67.9	84.0	92.4	40.9	PVC24	0.502

Dimensions are displayed in millimetres unless otherwise stated

# CX

## CX SINGLE SEAL INDUSTRIAL CABLE GLAND

### FOR BRAID, PLIABLE WIRE & STEEL TAPE ARMoured CABLES

- Standard material nickel plated brass
- High quality durable materials
- Robust, heavy duty design
- Metal-to-metal armour clamping
- Direct and remote installation
- Controlled outer load retention seal
- Unique OSTG prevents over tightening
- -60°C to +130°C (standard), -20°C to +200°C (ThermIn option)
- Deluge protection option
- Superior EMC performance

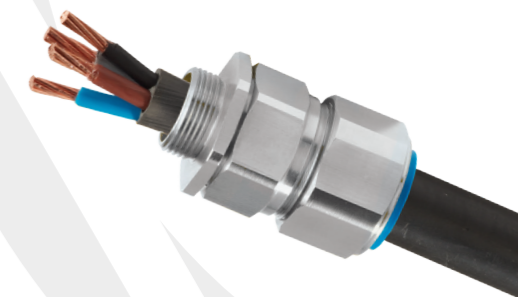

TECHNICAL CLASSIFICATION	
DESIGN SPECIFICATION	BS 6121: Part 1:1989, IEC 62444, EN 62444
MECHANICAL CLASSIFICATION*	Impact = Level 8, Cable Anchorage = Class D
ENCLOSURE PROTECTION	IK10 to IEC 62262 (20 joules) Brass & Stainless Steel only
ELECTRICAL CLASSIFICATIONS*	Category A
INGRESS PROTECTION RATING**	IP66 as standard (IP67, IP68*** available upon request)

CABLE GLAND MATERIAL	Electroless Nickel Plated Brass
CABLE TYPE	Wire Braid Armour, Screened Flexible (EMC) Wire Braid (e.g. CY / SY), Pliable Wire Armour (PWA), Steel Tape Armour (STA)
SEAL MATERIAL	CMP Thermoset Rubber
SEALING TECHNIQUE	CMP Load Retention Seal
SEALING AREA(S)	Cable Outer Sheath
ARMOUR CLAMPING	Detachable Armour Cone & AnyWay Universal Clamping Ring

\* Mechanical and Electrical Classifications applied as per IEC 62444 and EN 62444  
 \*\* When CMP installation accessories are used. Refer to www.cmp-products.com for further information. \*\*\* IP68 tested to a minimum depth of 30 metres for 12 hours, alternative depths / durations can be provided upon request

GLOBAL PRODUCT CERTIFICATION	
GOST R CERTIFICATE	POCC GB.HA46.H00140
MARINE APPROVALS	LRS: 01/00171, ABS: 16-LD1472056-PDA

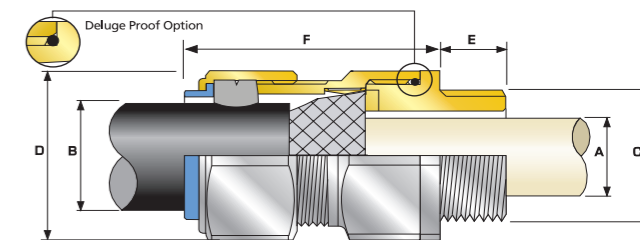

COMBINED ORDERING REFERENCE			AVAILABLE ENTRY THREADS 'C'		CABLE BEDDING DIAMETER 'A'	OVERALL CABLE DIAMETER 'B'		ARMOUR RANGE GROOVED CONE (X)		ACROSS FLATS 'D'	ACROSS CORNERS 'D'	PROTRUSION LENGTH 'F'	SHROUD	CABLE GLAND WEIGHT (kg)
SIZE	TYPE	ORDERING SUFFIX	METRIC	THREAD LENGTH 'E'	MAX	MIN	MAX	MIN	MAX	MAX	MAX			
20S16	CX	1RA5	M20	10.0	8.7	6.1	13.1	0.3	1.0	24.0	26.4	48.0	PVC04	0.100
20S	CX	1RA5	M20	10.0	11.7	9.5	15.9	0.3	1.0	24.0	26.4	48.0	PVC04	0.100
20	CX	1RA5	M20	10.0	14.0	12.5	20.9	0.4	1.0	30.5	33.6	48.0	PVC06	0.147
25S	CX	1RA5	M25	10.0	20.0	14.0	22.0	0.4	1.2	37.5	41.3	56.0	PVC09	0.224
25	CX	1RA5	M25	10.0	20.0	18.2	26.2	0.4	1.2	37.5	41.3	56.0	PVC09	0.221
32	CX	1RA5	M32	10.0	26.3	23.7	33.9	0.4	1.2	46.0	50.6	54.0	PVC11	0.306
40	CX	1RA5	M40	15.0	32.2	27.9	40.4	0.4	1.6	55.0	60.5	58.0	PVC15	0.448
50S	CX	1RA5	M50	15.0	38.2	35.2	46.7	0.4	1.6	60.0	66.0	61.0	PVC18	0.567
50	CX	1RA5	M50	15.0	44.1	40.4	53.0	0.6	1.6	70.1	77.1	60.0	PVC21	0.751
63S	CX	1RA5	M63	15.0	50.0	45.6	59.4	0.6	1.6	75.0	82.5	74.0	PVC23	1.036
63	CX	1RA5	M63	15.0	56.0	54.6	65.8	0.6	1.6	80.0	88.0	71.0	PVC25	1.016
75S	CX	1RA5	M75	15.0	62.0	59.0	72.0	0.6	1.6	90.0	99.0	86.0	PVC28	1.787
75	CX	1RA5	M75	15.0	68.0	66.7	78.4	0.6	1.6	100.0	110.0	82.0	PVC30	2.091
90	CX	1RA5	M90	24.0	78.6	76.2	90.3	0.8	1.6	114.3	125.7	95.0	PVC32	3.044
100	CX	1RA5	M100	24.0	91.0	86.1	101.4	0.8	1.6	123.0	135.3	95.0	LSF33	3.132
115	CX	1RA5	M115	24.0	98.0	101.5	110.2	0.8	1.6	133.4	146.7	107.5	LSF34	4.476
130	CX	1RA5	M130	24.0	115.0	110.2	123.2	0.8	1.6	152.4	167.6	110.0	LSF35	5.761

Dimensions are displayed in millimetres unless otherwise stated

# CWD

## CWD SINGLE SEAL, DELUGE PROTECTED INDUSTRIAL CABLE GLAND

### FOR ALL TYPES OF STEEL & ALUMINIUM WIRED ARMoured CABLES

- High quality durable materials
- Robust, heavy duty design
- Metal-to-metal armour clamping
- Direct and remote installation
- Controlled outer load retention seal
- Unique OSTG prevents over tightening
- -60°C to +130°C (standard), -20°C to +200°C (Thermln option)
- Deluge protected
- Superior EMC performance
- CWDVAR option available for copper tape screened SWA VSD cables
- Entry thread sealing washer and heavy duty locknut included as standard

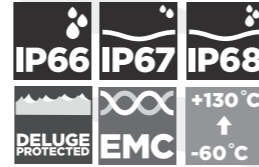
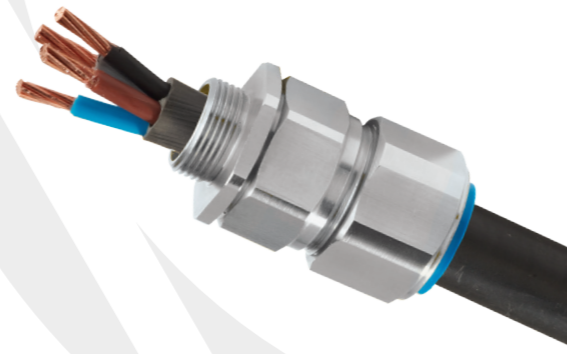

TECHNICAL CLASSIFICATION	
DESIGN SPECIFICATION	BS 6121: Part 1:1989, IEC 62444, EN 62444
MECHANICAL CLASSIFICATION	Impact = Level 8, Cable Anchorage = Class D
ENCLOSURE PROTECTION	IK10 to IEC 62262 (20 joules) Brass & Stainless Steel only
INGRESS PROTECTION RATING**	IP66, IP67 & IP68***
DELUGE PROTECTION COMPLIANCE	DTS01 : 91
CABLE TYPE	Single Wire Armour (SWA), Aluminium Wire Armour (AWA)
ARMOUR CLAMPING	Detachable Armour Cone & AnyWay Universal Clamping Ring
SEALING TECHNIQUE	CMP Load Retention Seal
SEALING AREA(S)	Cable Outer Sheath
CABLE GLAND MATERIAL	Electroless Nickel Plated Brass

GLOBAL PRODUCT CERTIFICATION	
GOST R CERTIFICATE	POCC GB.HA46.H00140
MARINE APPROVALS	LRS: 01/00171, ABS: 16-LD1472056-PDA

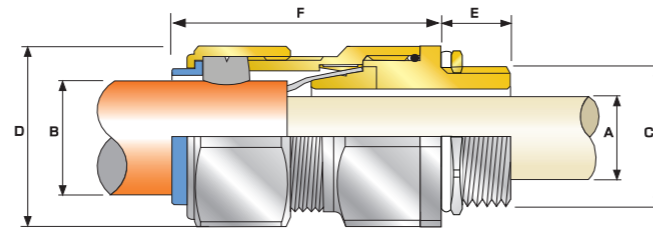

\* Mechanical and Electrical Classifications applied as per IEC 62444 and EN 62444 \*\* When CMP installation accessories are used. Refer to [www.cmp-products.com](http://www.cmp-products.com) for further information. \*\*\* IP68 tested to a minimum depth of 30 metres for 12 hours, alternative depths / durations can be provided upon request.

COMBINED ORDERING REFERENCE			AVAILABLE ENTRY THREADS		CABLE BEDDING DIAMETER 'A'	OVERALL CABLE DIAMETER 'B'			ARMOUR RANGE		ACROSS FLATS 'D'	ACROSS CORNERS 'D'	PROTRUSION LENGTH 'F'	SHROUD	CABLE GLAND WEIGHT (kg)
SIZE	TYPE	ORDERING SUFFIX	METRIC	THREAD LENGTH 'E'	MAX	MIN	MAX	MIN	MAX	MAX	MAX				
20S16	CWD	1RAS/A	M20	20.0	8.7	6.1	13.1	0.8	1.25	24.0	26.4	48.0	PVC04	0.100	
20S	CWD	1RAS/A	M20	20.0	11.7	9.5	15.9	0.8	1.25	24.0	26.4	48.0	PVC04	0.140	
20	CWD	1RAS/A	M20	20.0	14.0	12.5	20.9	0.8	1.25	30.5	33.6	48.0	PVC06	0.180	
25S	CWD	1RAS/A	M25	20.0	20.0	14.0	22.0	1.25	1.6	37.5	41.3	56.0	PVC09	0.257	
25	CWD	1RAS/A	M25	20.0	20.0	18.2	26.2	1.25	1.6	37.5	41.3	56.0	PVC09	0.257	
32	CWD	1RAS/A	M32	20.0	26.0	23.7	33.9	1.6	2.0	46.0	50.6	54.0	PVC11	0.376	
40	CWD	1RAS/A	M40	20.0	32.2	27.9	40.4	1.6	2.0	55.0	60.5	58.0	PVC15	0.630	
50S	CWD	1RAS/A	M50	20.0	38.2	35.2	46.7	2.0	2.5	60.0	66.0	61.0	PVC18	0.757	
50	CWD	1RAS/A	M50	20.0	44.1	40.4	53.0	2.0	2.5	70.1	77.1	60.0	PVC21	0.862	
63S	CWD	1RAS/A	M63	20.0	50.0	45.6	59.4	2.0	2.5	75.0	82.5	74.0	PVC23	1.390	
63	CWD	1RAS/A	M63	20.0	56.0	54.6	65.8	2.0	2.5	80.0	88.0	71.0	PVC25	1.360	
75S	CWD	1RAS/A	M75	20.0	62.0	59.0	72.0	2.0	2.5	90.0	99.0	86.0	PVC28	2.307	
75	CWD	1RAS/A	M75	20.0	68.0	66.7	78.4	2.5	3.0	100.0	110.0	82.0	PVC30	2.909	
90	CWD	1RAS/A	M90	24.0	78.6	76.2	90.3	3.15	4.0	114.3	125.7	95.0	PVC32	3.858	
100	CWD	1RAS/A	M100	24.0	91.0	86.1	101.4	3.15	4.0	123.0	135.3	95.0	LSF33	4.958	
115	CWD	1RAS/A	M115	24.0	98.0	101.5	110.2	3.15	4.0	135.4	146.7	107.5	LSF34	5.058	
130	CWD	1RAS/A	M130	24.0	115.0	110.2	123.2	3.15	4.0	152.4	167.6	110.0	LSF35	6.158	

Dimensions are displayed in millimetres unless otherwise stated

# A2F100 Simtars

## GLOBALLY APPROVED, EXPLOSIVE ATMOSPHERE CABLE GLAND

### FOR ALL TYPES OF UNARMoured CABLES

- Complies 100% with IEC 60079-0 cable retention requirements
- No 'special conditions' for safe use
- Simtars certified for QLD Group I mining applications
- Displacement type flameproof seal
- Deluge protected
- -60°C to +130°C
- Globally marked, IECEx and ATEX

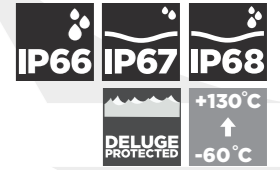

TECHNICAL DATA	
DESIGN SPECIFICATION	BS 6121:Part 1:1989, IEC 62444, EN 62444
MECHANICAL CLASSIFICATION*	Impact = Level 8, Cable Anchorage = Class B
ENCLOSURE PROTECTION	IK10 to IEC 62262 (20 joules)
INGRESS PROTECTION RATING**	IP66, IP67 & IP68***
DELUGE PROTECTION COMPLIANCE	DTS01 : 91

GLOBAL PRODUCT CERTIFICATION			
ATEX CERTIFICATE	CML 18ATEX1307 CML 18ATEX4311	IECEx CERTIFICATE	IECEx CML 18.0172 IECEx SIM 17.0010
CODE OF PROTECTION	Ⓜ II 2G 1D, Ex db IIC Gb, Ex eb IIC Gb, Ex ta IIIC Da Ⓜ II 3G Ex nR IIC Gc Ⓜ I M2 Ex db I Mb, Ex eb I Mb	CODE OF PROTECTION	Ex db IIC Gb, Ex eb IIC Gb, Ex ta IIIC Da, Ex nR IIC Gc, Ex db I Mb, Ex eb I Mb
COMPLIANCE STANDARDS	EN 60079-0,1,7,15,31	COMPLIANCE STANDARDS	IEC 60079-0,1,7,15,31

\* Mechanical and Electrical Classifications applied as per IEC 62444 and EN 62444 \*\* When CMP installation accessories are used. Refer to [www.cmp-products.com](http://www.cmp-products.com) for further information. \*\*\* IP68 tested to a minimum depth of 30 metres for 12 hours, alternative depths / durations can be provided upon request.

CABLE GLAND MATERIAL	Electroless Nickel Plated Brass
SEAL MATERIAL	CMP SOLO LSF Halogen Free Thermoset Elastomer
CABLE TYPE	Unarmoured and Braided (Braid terminated inside enclosure)
SEALING TECHNIQUE	CMP Displacement Seal
SEALING AREA(S)	Cable Outer Sheath

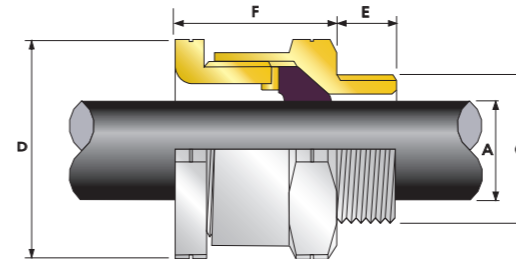

COMBINED ORDERING REFERENCE			AVAILABLE ENTRY THREADS 'C'		OVERALL CABLE DIAMETER 'A'		ACROSS FLATS 'D'	ACROSS CORNERS 'D'	PROTRUSION LENGTH 'F'	SHROUD	CABLE GLAND WEIGHT (kg)
SIZE	TYPE	ORDERING SUFFIX	METRIC	THREAD LENGTH 'E'	MIN	MAX	MAX	MAX			
16	A2F100	1RAS	M16	15.0	3.2	8.0	24.0	26.4	34.9	PVC04	0.07
20S16	A2F100	1RAS	M20	15.0	3.2	8.0	24.0	26.4	30.4	PVC04	0.08
20S	A2F100	1RAS	M20	15.0	6.5	11.2	24.0	26.4	31.9	PVC04	0.07
20	A2F100	1RAS	M20	15.0	7.0	13.5	27.0	29.7	35.8	PVC05	0.09
20L	A2F100	1RAS	M20	15.0	8.7	14.0	27.0	29.7	34.3	PVC05	0.09
25	A2F100	1RAS	M25	15.0	11.5	19.5	36.0	39.6	40.4	PVC09	0.16
25L	A2F100	1RAS	M25	15.0	14.0	20.0	36.0	39.6	39.9	PVC09	0.16
32	A2F100	1RAS	M32	15.0	19.0	25.5	41.0	45.1	38.5	PVC10	0.18
32L	A2F100	1RAS	M32	15.0	20.2	26.3	41.0	45.1	35.5	PVC10	0.18
40	A2F100	1RAS	M40	15.0	25.0	32.2	50.0	55.0	38.8	PVC13	0.25
50S	A2F100	1RAS	M50	15.0	31.0	38.2	55.0	60.5	41.4	PVC15	0.33
50	A2F100	1RAS	M50	15.0	35.6	44.0	60.0	66.0	45.8	PVC18	0.35
63S	A2F100	1RAS	M63	15.0	41.5	49.9	70.5	77.6	43.3	PVC21	0.56
63	A2F100	1RAS	M63	15.0	48.2	54.9	75.0	82.5	43.6	PVC23	0.55
75S	A2F100	1RAS	M75	15.0	54.0	61.9	84.0	92.4	45.4	PVC24	0.73
75	A2F100	1RAS	M75	15.0	61.1	67.9	84.0	92.4	49.0	PVC24	0.58
90	A2F100	1RAS	M90	24.0	66.6	79.9	108.0	118.8	66.0	PVC31	1.71
100	A2F100	1RAS	M100	24.0	76.0	89.0	123.0	135.3	72.2	LSF33	2.26
115	A2F100	1RAS	M115	24.0	86.0	97.9	133.4	146.7	67.9	LSF34	2.74
130	A2F100	1RAS	M130	24.0	97.0	114.9	152.4	167.6	81.1	LSF35	4.07

Dimensions are displayed in millimetres unless otherwise stated

# A2F100HC Simtars

**GLOBALLY APPROVED, EXPLOSIVE ATMOSPHERE CABLE GLAND**

**FOR ALL TYPES OF UNARMoured CABLES HOUSED IN FRAS HOSE**

- Complies 100% with IEC 60079-0 cable retention requirements
- No 'special conditions' for safe use
- Simtars certified for QLD Group I mining applications
- External hose connection facility
- Approved for Group I and Group II
- High quality durable materials
- Wide sealing range for each cable gland size
- Displacement type flameproof seal
- 60°C to +130°C
- Globally marked, IECEx and ATEX

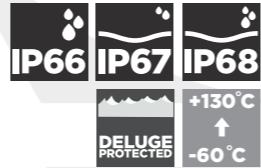

**Ex db Ex eb Ex ta ExnR**

TECHNICAL DATA	
DESIGN SPECIFICATION	BS 6121:Part 1:1989, IEC 62444, EN 62444
MECHANICAL CLASSIFICATION*	Impact = Level 8, Cable Anchorage = Class B
ENCLOSURE PROTECTION	IK10 to IEC 62262 (20 joules)
INGRESS PROTECTION RATING**	IP66, IP67 & IP68***
DELUGE PROTECTION COMPLIANCE	DTS01 : 91

CABLE GLAND MATERIAL	Electroless Nickel Plated Brass
SEAL MATERIAL	CMP SOLO LSF Halogen Free Thermoset Elastomer
CABLE TYPE	Unarmoured & enclosed within hose for mechanical protection
SEALING TECHNIQUE	CMP Displacement Seal
SEALING AREA(S)	Cable Outer Sheath

GLOBAL PRODUCT CERTIFICATION			
ATEX CERTIFICATE	CML 18ATEX1307 CML 18ATEX4311	IECEx CERTIFICATE	IECEx CML 18.0172 IECEx SIM 17.0010
CODE OF PROTECTION	Ⓜ II 2G 1D, Ex db IIC Gb, Ex eb IIC Gb, Ex ta IIIC Da Ⓜ II 3G Ex nR IIC Gc Ⓜ I M2 Ex db I Mb, Ex eb I Mb	CODE OF PROTECTION	Ex db IIC Gb, Ex eb IIC Gb, Ex ta IIIC Da, Ex nR IIC Gc, Ex db I Mb, Ex eb I Mb
COMPLIANCE STANDARDS	EN 60079-0,1,7,15,31	COMPLIANCE STANDARDS	IEC 60079-0,1,7,15,31

\* Mechanical and Electrical Classifications applied as per IEC 62444 and EN 62444  
 \*\* When CMP installation accessories are used. Refer to [www.cmp-products.com](http://www.cmp-products.com) for further information.  
 \*\*\* IP68 tested to a minimum depth of 30 metres for 12 hours, alternative depths / durations can be provided upon request.

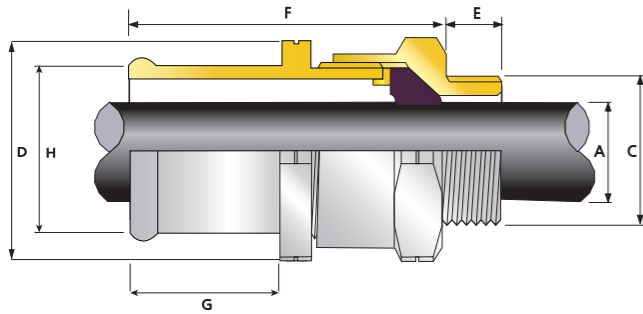

COMBINED ORDERING REFERENCE			AVAILABLE ENTRY THREADS 'C'		OVERALL CABLE DIAMETER 'A'		HOSE SIZE 'H'	ACROSS FLATS 'D'	ACROSS CORNERS 'D'	PROTRUSION LENGTH 'F'	HOSE CONNECTION LENGTH 'G'	CABLE GLAND WEIGHT (kg)
SIZE	TYPE	ORDERING SUFFIX	METRIC	THREAD LENGTH 'E'	MIN	MAX						
20S16	A2F100HC13	1RA5	M20	15.0	3.2	8.0	13.0	24.0	26.4	30.4	16.0	0.122
20S16	A2F100HC16	1RA5	M20	15.0	3.2	8.0	16.0	24.0	26.4	46.4	16.0	0.131
20S	A2F100HC16	1RA5	M20	15.0	6.5	11.2	16.0	24.0	26.4	47.9	16.0	0.113
20	A2F100HC16	1RA5	M20	15.0	7.0	11.9	16.0	27.0	29.7	55.8	20.0	0.140
20	A2F100HC19	1RA5	M20	15.0	7.0	13.5	19.0	27.0	29.7	55.8	20.0	0.140
20L	A2F100HC19	1RA5	M20	15.0	8.7	14.0	19.0	27.0	29.7	54.3	20.0	0.138
25	A2F100HC19	1RA5	M25	15.0	11.5	14.0	19.0	36.0	39.6	40.4	20.0	0.241
25	A2F100HC25	1RA5	M25	15.0	11.5	19.5	25.0	36.0	39.6	67.4	27.0	0.240
25L	A2F100HC25	1RA5	M25	15.0	14.0	20.0	25.0	36.0	39.6	66.9	27.0	0.238
32	A2F100HC25	1RA5	M32	15.0	19.0	20.0	25.0	41.0	45.1	38.5	27.0	0.288
32	A2F100HC32	1RA5	M32	15.0	19.0	25.5	32.0	41.0	45.1	71.5	33.0	0.299
32L	A2F100HC32	1RA5	M32	15.0	20.2	26.3	32.0	41.0	45.1	68.5	33.0	0.295
40	A2F100HC38	1RA5	M40	15.0	25.0	32.2	38.0	50.0	55.0	79.8	41.0	0.430
50S	A2F100HC51	1RA5	M50	15.0	31.0	38.2	51.0	55.0	60.5	95.4	54.0	0.838
50	A2F100HC51	1RA5	M50	15.0	35.6	44.0	60.0	66.0	66.0	99.8	54.0	0.674
63S	A2F100HC63	1RA5	M63	15.0	41.5	49.9	63.0	70.5	77.6	113.3	70.0	1.352
63	A2F100HC63	1RA5	M63	15.0	48.2	54.9	63.0	75.0	82.5	113.6	70.0	1.032
75S	A2F100HC76	1RA5	M75	15.0	54.0	61.9	76.0	84.0	92.4	136.9	91.5	2.101
75	A2F100HC76	1RA5	M75	15.0	61.1	67.9	76.0	84.0	92.4	140.5	91.5	1.492

Note: Dimensions across hose connections may vary  
 Dimensions are displayed in millimetres unless otherwise stated

# SS2K

**SS2K DOUBLE SEAL, GLOBALLY APPROVED, EXPLOSIVE ATMOSPHERE CABLE GLAND**

**FOR ALL TYPES OF UNARMoured CABLE**

- Provides double seal on outer sheath or single on outer and inner
- Direct and remote installation
- Superior levels of cable retention
- Displacement type flameproof seal
- Deluge protected
- 60°C to +130°C (standard), -20°C to +200°C (ThermEx option)
- Long thread option available
- Globally marked, IECEx, ATEX and CSA

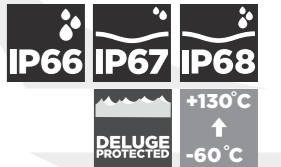

**Ex db Ex eb Ex ta ExnR**

TECHNICAL CLASSIFICATION	
DESIGN SPECIFICATION	BS 6121: Part 1:1989, IEC 62444, EN 62444
MECHANICAL CLASSIFICATION*	Impact = Level 8, Cable Anchorage = Class B
ENCLOSURE PROTECTION	IK10 to IEC 62262 (20 joules) Brass & Stainless Steel only
INGRESS PROTECTION RATING**	IP66, IP67 & IP68***
DELUGE PROTECTION COMPLIANCE	DTS01 : 91

CABLE TYPE	Unarmoured and Braided (Braid terminated inside enclosure)
SEAL MATERIAL	CMP SOLO LSF Halogen Free Thermoset Elastomer
SEALING TECHNIQUE	CMP Displacement Seal
SEALING AREA(S)	Cable Inner Bedding & Outer Cable Sheath, Double Seal on Cable Outer Sheath
CABLE GLAND MATERIAL	Electroless Nickel Plated Brass

\* Mechanical and Electrical Classifications applied as per IEC 62444 and EN 62444 \*\* When CMP installation accessories are used. Refer to [www.cmp-products.com](http://www.cmp-products.com) for further information.  
 \*\*\* IP68 tested to a minimum depth of 30 metres for 12 hours, alternative depths / durations can be provided upon request

GLOBAL PRODUCT CERTIFICATION			
ATEX CERTIFICATE	CML 18ATEX1322X CML 18ATEX4314X	IECEx CERTIFICATE	IECEx CML 18.0178X
CODE OF PROTECTION	Ⓜ II 2G 1D, Ex db IIC Gb, Ex eb IIC Gb, Ex ta IIIC Da Ⓜ II 3G Ex nR IIC Gc Ⓜ I M2 Ex db I Mb, Ex eb I Mb	CODE OF PROTECTION	Ex db IIC Gb, Ex eb IIC Gb, Ex nR IIC Gc, Ex ta IIIC Da, Ex db I Mb, Ex eb I Mb
COMPLIANCE STANDARDS	EN 60079-0,1,7,15,31	COMPLIANCE STANDARDS	IEC 60079-0,1,7,15,31
CSA CERTIFICATE	1211841		
CODE OF PROTECTION	Ex d IIC, Ex e II, Ex nR II, Enclosure Type 4x		
COMPLIANCE STANDARDS	CSA C22.2 No 0,0,4, 94, 174; CSA C22.2 No 60079-0,1,7, 15		
UkrSEPRO CERTIFICATE	CL19.0371X	EAC CERTIFICATE	TC RU C-G. A07.8.04596/22
CCOE / PESO (INDIA) CERTIFICATE	P548696, P533772, P548695	INMETRO APPROVAL	TUV 12.0879X
RETIE APPROVAL NUMBER	03866		
MARINE APPROVALS	LRS: 01/00172, DNV: TAE000000Y, ABS: 20-LD1948801-PDA, BV: 43180 A1 BV		

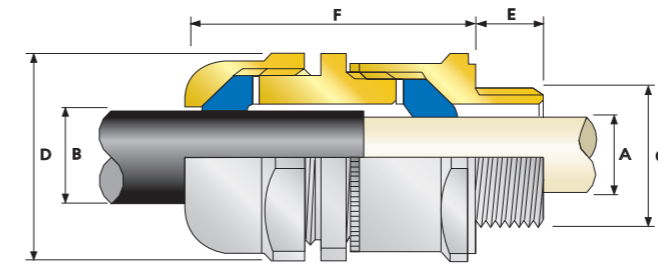

COMBINED ORDERING REFERENCE			AVAILABLE ENTRY THREADS 'C'		CABLE BEDDING DIAMETER 'A'		OVERALL CABLE DIAMETER 'B'		ACROSS FLATS 'D'	ACROSS CORNERS 'D'	PROTRUSION LENGTH 'F'	SHROUD	CABLE GLAND WEIGHT (kg)
SIZE	TYPE	ORDERING SUFFIX	METRIC	THREAD LENGTH 'E'	MIN	MAX	MIN	MAX	MAX	MAX			
20S16	SS2K	1RA5	M20	15.0	3.2	8.6	3.2	8.6	24.0	26.4	49.0	PVC04	0.140
20S	SS2K	1RA5	M20	15.0	6.1	11.7	6.1	11.7	24.0	26.4	49.0	PVC04	0.130
20	SS2K	1RA5	M20	15.0	6.5	14.0	6.5	14.0	27.0	29.7	54.0	PVC05	0.160
25	SS2K	1RA5	M25	15.0	11.1	20.0	11.1	20.0	36.0	39.6	66.0	PVC09	0.300
32	SS2K	1RA5	M32	15.0	17.0	26.3	17.0	26.3	41.0	45.1	67.0	PVC10	0.350
40	SS2K	1RA5	M40	15.0	23.5	32.1	23.5	32.1	50.0	55.0	70.0	PVC13	0.500
50S	SS2K	1RA5	M50	15.0	31.0	38.2	31.0	38.2	55.0	60.5	65.0	PVC15	0.560
50	SS2K	1RA5	M50	15.0	35.6	44.0	35.6	44.0	60.0	66.0	70.0	PVC18	0.590
63S	SS2K	1RA5	M63	15.0	41.5	49.9	41.5	49.9	70.5	77.6	70.0	PVC21	0.890
63	SS2K	1RA5	M63	15.0	47.2	55.9	47.2	55.9	75.0	82.5	71.0	PVC23	0.850
75S	SS2K	1RA5	M75	15.0	54.0	61.9	54.0	61.9	80.0	88.0	70.0	PVC26	1.020
75	SS2K	1RA5	M75	15.0	61.1	67.9	61.1	67.9	84.0	92.4	75.0	PVC26	0.990
90	SS2K	1RA5	M90	24.0	66.6	79.4	66.6	79.4	108.0	118.8	113.0	PVC31	2.990
100	SS2K	1RA5	M100	24.0	76.0	90.9	76.0	90.9	123.0	134.2	106.0	LSF33	3.390
115	SS2K	1RA5	M115	24.0	86.0	97.9	86.0	97.9	133.4	146.7	128.0	LSF34	5.320
130	SS2K	1RA5	M130	24.0	97.0	114.9	97.0	114.9	152.4	167.6	129.0	LSF35	6.350

Dimensions are displayed in millimetres unless otherwise stated

TRITON CDS (T3CDS) GLOBALLY APPROVED, EXPLOSIVE ATMOSPHERE CABLE GLAND

FOR ALL TYPES OF ARMoured CABLES

- Fully sequential, three step installation procedure
- Reduces installation times, cost and risk
- Direct and remote installation
- Unique compensating displacement seal system (CDS)
- Metal-to-metal installation every time regardless of cable diameter
- Designed to reduce the effects of coldflow. See CMP Technical Doc TS002
- Integral protected deluge seal
- Controlled outer load retention seal
- Unique OSTG prevents over tightening
- 60°C to +130°C (standard), -20°C to +200°C (ThermEx option)
- Globally marked, UL, cCSAus, IECEX and ATEX
- T3CDSVAR Option available for copper tape screened SWA VSD cables



TECHNICAL CLASSIFICATION	
DESIGN SPECIFICATION	BS 6121: Part 1:1989, IEC 62444, EN 62444
MECHANICAL CLASSIFICATION*	Impact = Level 8, Cable Anchorage = Class D
ENCLOSURE PROTECTION	IK10 to IEC 62262 (20 joules) Brass & Stainless Steel only
ELECTRICAL CLASSIFICATION*	Category B (Category A when used with braid, tape or pliable wire armour cables)
INGRESS PROTECTION RATING**	IP66, IP67 & IP68***
DELUGE PROTECTION COMPLIANCE	DTS01 : 91

CABLE GLAND MATERIAL	Electroless Nickel Plated Brass
SEAL MATERIAL	CMP SOLO LSF Halogen Free Thermoset Elastomer
CABLE TYPE(S)	Steel / Served Wire Armour (SWA), Aluminium Wire Armour (AWA), Pliable Wire Armour (PWA), Steel Tape Armour (STA), Aluminium Strip Armour (ASA), Screened Flexible (EMC) Wire Braid (e.g. CY/SY), Wire Braid Armour (e.g. SWB)
ARMOUR CLAMPING	Reversible Armour Cone & AnyWay Universal Clamping Ring
SEALING TECHNIQUE	CMP Inner Compensating Displacement Seal (CDS) and Outer Load Retention Seal
SEALING AREA(S)	Cable Inner Bedding & Outer Cable Sheath

\* Mechanical and Electrical Classifications applied as per IEC 62444 and EN 62444 \*\* When CMP installation accessories are used. Refer to www.cmp-products.com for further information. \*\*\* IP68 tested to a minimum depth of 30 metres for 12 hours, alternative depths / durations can be provided upon request

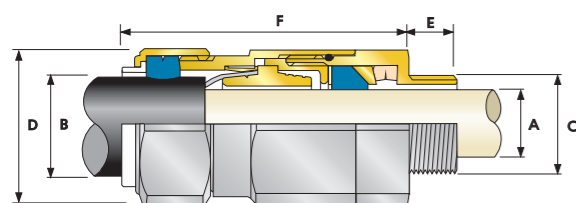

COMBINED ORDERING REFERENCE	AVAILABLE ENTRY THREADS 'C'		CABLE BEDDING DIAMETER 'A'		OVERALL CABLE DIAMETER 'B'		ARMOUR RANGE				ACROSS FLATS 'D'	ACROSS CORNERS 'D'	PROTRUSION LENGTH 'F'	SHROUD	CABLE GLAND WEIGHT (kg)		
	METRIC	MINIMUM THREAD LENGTH 'E'	MIN	MAX	MIN	MAX	GROOVED CONE (X)		STEPPED CONE (W)								
20S16	T3CDS	1RA5	M20	15.0	3.1	8.6	6.1	13.1	0.3	1.0	0.8	1.25	24.0	26.4	78.7	PVC36	0.18
20S	T3CDS	1RA5	M20	15.0	6.1	11.6	9.5	15.9	0.3	1.0	0.8	1.25	24.0	26.4	78.7	PVC36	0.20
20	T3CDS	1RA5	M20	15.0	6.5	13.9	12.5	20.9	0.4	1.0	0.8	1.25	30.5	33.6	76.2	PVC06	0.28
25S	T3CDS	1RA5	M25	15.0	11.1	19.9	14.0	22.0	0.4	1.2	1.25	1.6	37.5	41.3	88.8	PVC09	0.44
25	T3CDS	1RA5	M25	15.0	11.1	19.9	18.2	26.2	0.4	1.2	1.25	1.6	37.5	41.3	88.7	PVC09	0.44
32	T3CDS	1RA5	M32	15.0	17.0	26.2	23.7	33.9	0.4	1.2	1.6	2.0	46.0	50.6	90.7	PVC11	0.63
40	T3CDS	1RA5	M40	15.0	22.0	32.1	27.9	40.4	0.4	1.6	1.6	2.0	55.0	60.5	93.2	PVC15	0.91
50S	T3CDS	1RA5	M50	15.0	29.5	38.1	35.2	46.7	0.4	1.6	2.0	2.5	60.0	66.0	100.7	PVC18	1.12
50	T3CDS	1RA5	M50	15.0	35.6	44.0	40.4	53.0	0.6	1.6	2.0	2.5	70.1	77.1	105.8	PVC21	1.60
63S	T3CDS	1RA5	M63	15.0	40.1	49.9	45.6	59.4	0.6	1.6	2.0	2.5	75.0	82.5	102.5	PVC23	1.73
63	T3CDS	1RA5	M63	15.0	47.2	55.9	54.6	65.8	0.6	1.6	2.0	2.5	80.0	88.0	105.4	PVC25	1.78
75S	T3CDS	1RA5	M75	15.0	52.8	61.9	59.0	72.0	0.6	1.6	2.0	2.5	90.0	99.0	110.6	PVC28	2.57
75	T3CDS	1RA5	M75	15.0	59.1	67.9	66.7	78.4	0.6	1.6	2.5	3.0	100.0	110.0	120.3	PVC30	3.33
90	T3CDS	1RA5	M90	24.0	66.6	78.6	76.2	90.3	0.8	1.6	3.15	4.0	115.0	126.5	138.9	PVC32	4.87
100	T3CDS	1RA5	M100	24.0	76.0	90.9	86.1	101.4	0.8	1.6	3.15	4.0	127.0	139.7	128.2	LSF33	4.97
115	T3CDS	1RA5	M115	24.0	86.0	97.9	101.5	110.2	0.8	1.6	3.15	4.0	138.0	151.8	161.3	LSF34	7.72
130	T3CDS	1RA5	M130	24.0	97.0	114.9	110.2	123.2	0.8	1.6	3.15	4.0	157.0	172.7	173.3	LSF35	9.78

Dimensions are displayed in millimetres unless otherwise stated

E1FW

E1FW GLOBALLY APPROVED, EXPLOSIVE ATMOSPHERE CABLE GLAND

FOR ALL TYPES OF STEEL & ALUMINIUM WIRE ARMoured CABLES

- Metal-to-metal armour clamping
- Direct and remote installation
- Displacement type flameproof inner seal
- Controlled outer load retention seal
- Unique OSTG prevents overtightening
- 60°C to +130°C
- Globally marked, IECEX, ATEX and cCSAus
- Superior EMC performance
- Long thread option available

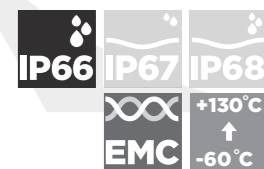
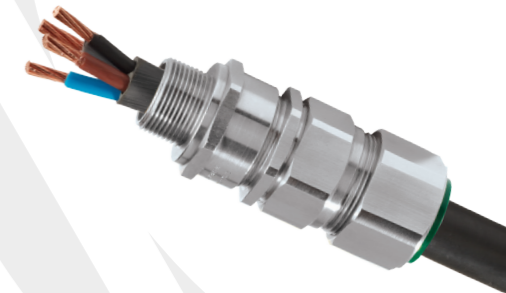

TECHNICAL CLASSIFICATION	
DESIGN SPECIFICATION	BS 6121: Part 1:1989, IEC 62444, EN 62444
MECHANICAL CLASSIFICATION*	Impact = Level 8, Cable Anchorage = Class D
ENCLOSURE PROTECTION	IK10 to IEC 62262 (20 joules)
ELECTRICAL CLASSIFICATION*	Category B
INGRESS PROTECTION RATING**	IP66 as standard (IP67, IP68*** available upon request)
DELUGE PROTECTION COMPLIANCE	DTS01 : 91 option available on request (white ferrule for identification purposes)

CABLE GLAND MATERIAL	Electroless Nickel Plated Brass
SEAL MATERIAL	CMP SOLO LSF Halogen Free Thermoset Elastomer
CABLE TYPE	Single Wire Armour (SWA), Aluminium Wire Armour (AWA)
ARMOUR CLAMPING	Detachable Armour Cone & AnyWay Universal Clamping Ring
SEALING TECHNIQUE	CMP Inner Displacement Seal and Outer Load Retention Seal
SEALING AREA(S)	Cable Inner Bedding & Outer Cable Sheath

\* Mechanical and Electrical Classifications applied as per IEC 62444 and EN 62444 \*\* When CMP installation accessories are used. Refer to www.cmp-products.com for further information. \*\*\* IP68 tested to a minimum depth of 30 metres for 12 hours, alternative depths / durations can be provided upon request

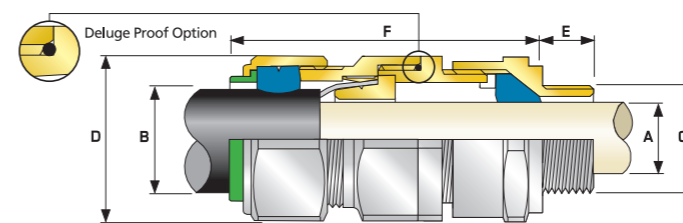

COMBINED ORDERING REFERENCE	AVAILABLE ENTRY THREADS 'C'		CABLE BEDDING DIAMETER 'A'		OVERALL CABLE DIAMETER 'B'		ARMOUR RANGE		ACROSS FLATS 'D'	ACROSS CORNERS 'D'	PROTRUSION LENGTH 'F'	SHROUD	CABLE GLAND WEIGHT (kg)		
	SIZE	TYPE	ORDERING SUFFIX	METRIC	THREAD LENGTH 'E'	MIN	MAX	MIN						MAX	
20S16	E1FW	1RAS	M20	15.0	3.1	8.6	6.1	13.1	0.8	1.25	24.0	26.4	72.5	PVC04	0.16
20S	E1FW	1RAS	M20	15.0	6.1	11.6	9.5	15.9	0.8	1.25	24.0	26.4	70.0	PVC04	0.15
20	E1FW	1RAS	M20	15.0	6.5	13.9	12.5	20.9	0.8	1.25	30.5	33.6	73.0	PVC06	0.21
25S	E1FW	1RAS	M25	15.0	11.1	19.9	14.0	22.0	1.25	1.6	37.5	41.3	89.0	PVC09	0.33
25	E1FW	1RAS	M25	15.0	11.1	19.9	18.2	26.2	1.25	1.6	37.5	41.3	89.0	PVC09	0.33
32	E1FW	1RAS	M32	15.0	17.0	26.2	23.7	33.9	1.6	2.0	46.0	50.6	86.0	PVC11	0.43
40	E1FW	1RAS	M40	15.0	22.0	32.1	27.9	40.4	1.6	2.0	55.0	60.5	90.0	PVC15	0.62
50S	E1FW	1RAS	M50	15.0	29.5	38.1	35.2	46.7	2.0	2.5	60.0	66.0	91.0	PVC18	0.75
50	E1FW	1RAS	M50	15.0	35.6	44.0	40.4	53.0	2.0	2.5	70.1	77.1	95.0	PVC21	0.95
63S	E1FW	1RAS	M63	15.0	40.1	49.9	45.6	59.4	2.0	2.5	75.0	82.5	102.0	PVC23	1.34
63	E1FW	1RAS	M63	15.0	47.2	55.9	54.6	65.8	2.0	2.5	80.0	88.0	104.0	PVC25	1.34
75S	E1FW	1RAS	M75	15.0	52.8	61.9	59.0	72.0	2.0	2.5	90.0	99.0	115.0	PVC28	2.11
75	E1FW	1RAS	M75	15.0	59.1	67.9	66.7	78.4	2.0	2.5	100.0	110.0	117.0	PVC30	2.42
90	E1FW	1RAS	M90	24.0	66.6	78.6	76.2	90.3	3.15	4.0	115.0	126.5	147.0	PVC32	4.21
100	E1FW	1RAS	M100	24.0	76.0	90.9	86.1	101.4	3.15	4.0	127.0	139.7	140.0	LSF33	4.45
115	E1FW	1RAS	M115	24.0	86.0	97.9	101.5	110.2	3.15	4.0	138.0	151.8	162.0	LSF34	6.19
130	E1FW	1RAS	M130	24.0	97.0	114.9	110.2	123.2	3.15	4.0	157.0	172.7	174.0	LSF35	8.34

Dimensions are displayed in millimetres unless otherwise stated



# E1FX

**E1FX GLOBALLY APPROVED, EXPLOSIVE ATMOSPHERE CABLE GLAND**

**FOR BRAIDED & STEEL TAPE ARMoured CABLES**

- Metal-to-metal armour clamping
- Direct and remote installation
- Displacement type flameproof inner seal
- Controlled outer load retention seal
- Unique OSTG prevents overtightening
- -60°C to +130°C
- Globally marked, IECEX, ATEX and cCSAus
- Superior EMC performance
- Long thread option available

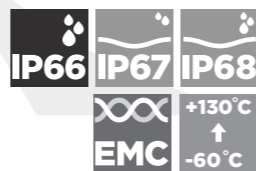

Ex db Ex eb Ex ta Ex nR

TECHNICAL CLASSIFICATION	
DESIGN SPECIFICATION	BS 6121: Part 1:1989, IEC 62444, EN 62444
MECHANICAL CLASSIFICATION*	Impact = Level 8, Cable Anchorage = Class B
ENCLOSURE PROTECTION	IK10 to IEC 62262 (20 joules) Brass only
ELECTRICAL CLASSIFICATION**	Category B (Category A when used with braid, tape or pliable wire armour cables)
INGRESS PROTECTION RATING**	IP66 as standard (IP67, IP68*** available upon request)
DELUGE PROTECTION COMPLIANCE	DTS01: 91 option available on request (white ferrule for identification purposes)
CABLE GLAND MATERIAL	Electroless Nickel Plated Brass
SEAL MATERIAL	CMP SOLO LSF Halogen Free Thermoset Elastomer
CABLE TYPE	Screened Flexible (EMC) Wire Braid (e.g. CY / SY), Pliable Wire Armour (PWA), Steel Tape Armour (STA), Wire Braid Armour (e.g. SWB), Aluminium Strip Armour (ASA), Armoured & Jacketed
ARMOUR CLAMPING	Detachable Armour Cone & AnyWay Universal Clamping Ring
SEALING TECHNIQUE	CMP Inner Displacement Seal and Outer Load Retention Seal
SEALING AREA(S)	Cable Inner Bedding & Outer Cable Sheath

\* Mechanical and Electrical Classifications applied as per IEC 62444 and EN 62444 \*\* When CMP installation accessories are used. Refer to [www.cmp-products.com](http://www.cmp-products.com) for further information. \*\*\* IP68 tested to a minimum depth of 30 metres for 12 hours, alternative depths / durations can be provided upon request.

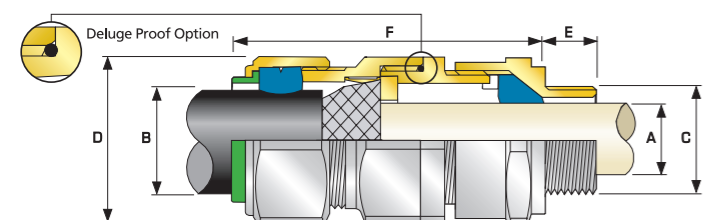

COMBINED ORDERING REFERENCE			AVAILABLE ENTRY THREADS *C		CABLE BEDDING DIAMETER *A		OVERALL CABLE DIAMETER *B		ARMOUR RANGE GROOVED CONE (X)		CROSS FLATS *D	CROSS CORNERS *D'	PROTRUSION LENGTH *F	SHROUD	CABLE GLAND WEIGHT (kg)
SIZE	TYPE	ORDERING SUFFIX	METRIC	THREAD LENGTH *E	MIN	MAX	MIN	MAX	MIN	MAX	MAX	MAX			
20S16	E1FX	1RA5	M20	15.0	3.1	8.6	6.1	13.1	0.3	1.0	24.0	26.4	72.5	PVC04	0.16
20S	E1FX	1RA5	M20	15.0	6.1	11.6	9.5	15.9	0.3	1.0	24.0	26.4	70.0	PVC04	0.15
20	E1FX	1RA5	M20	15.0	6.5	13.9	12.5	20.9	0.4	1.0	30.5	33.6	73.0	PVC06	0.21
25S	E1FX	1RA5	M25	15.0	11.1	19.9	14.0	22.0	0.4	1.2	37.5	41.3	89.0	PVC09	0.33
25	E1FX	1RA5	M25	15.0	11.1	19.9	18.2	26.2	0.4	1.2	37.5	41.3	89.0	PVC09	0.33
32	E1FX	1RA5	M32	15.0	17.0	26.2	23.7	33.9	0.4	1.2	46.0	50.6	86.0	PVC11	0.43
40	E1FX	1RA5	M40	15.0	22.0	32.1	27.9	40.4	0.4	1.6	55.0	60.5	90.0	PVC15	0.62
50S	E1FX	1RA5	M50	15.0	29.5	38.1	35.2	46.7	0.4	1.6	60.0	66.0	91.0	PVC18	0.75
50	E1FX	1RA5	M50	15.0	35.6	44.0	40.4	53.0	0.6	1.6	70.1	77.1	95.0	PVC21	0.95
63S	E1FX	1RA5	M63	15.0	40.1	49.9	45.6	59.4	0.6	1.6	75.0	82.5	102.0	PVC23	1.34
63	E1FX	1RA5	M63	15.0	47.2	55.9	54.6	65.8	0.6	1.6	80.0	88.0	104.0	PVC25	1.34
75S	E1FX	1RA5	M75	15.0	52.8	61.9	59.0	72.0	0.6	1.6	90.0	99.0	115.0	PVC28	2.11
75	E1FX	1RA5	M75	15.0	59.1	67.9	66.7	78.4	0.6	1.6	100.0	110.0	117.0	PVC30	2.42
90	E1FX	1RA5	M90	24.0	66.6	78.6	76.2	90.3	0.8	1.6	114.3	125.4	147.0	PVC32	4.21
100	E1FX	1RA5	M100	24.0	76.0	90.9	86.1	101.4	0.8	1.6	123.0	135.3	140.0	LSF33	4.45
115	E1FX	1RA5	M115	24.0	86.0	97.9	101.5	110.2	0.8	1.6	133.4	146.7	162.0	LSF34	6.19
130	E1FX	1RA5	M130	24.0	97.0	114.9	110.2	123.2	0.8	1.6	152.4	167.6	174.0	LSF35	8.34

Dimensions are displayed in millimetres unless otherwise stated

# PX2KREX



**PX2KREX GLOBALLY APPROVED, EXPLOSIVE ATMOSPHERE RAPIDEX BARRIER CABLE GLAND**

**FOR ALL TYPES OF ARMoured CABLES**

- RapidEx liquid pour sealing system reduces installation time
- Metal-to-metal armour clamping
- Direct and remote installation
- Integral protected deluge seal
- Controlled outer load retention seal
- Unique OSTG prevents over tightening
- -60°C to +85°C
- Globally marked, cCSAus, IECEX and ATEX
- Superior EMC performance
- RapidEx liquid barrier resin seals around internal cable cores after removing any cable inner sheath/ bedding; completely eliminating any risk of coldflow

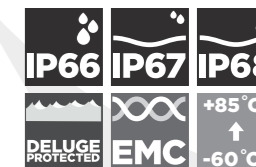
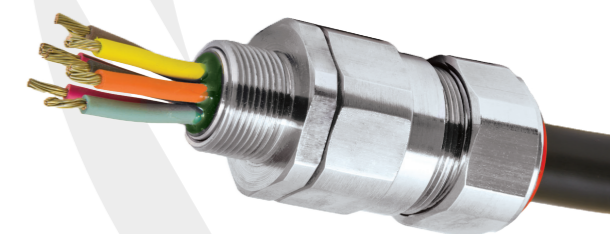

Ex db Ex eb Ex ta Ex nR

TECHNICAL CLASSIFICATION	
DESIGN SPECIFICATION	BS 6121: Part 1:1989, IEC 62444, EN 62444
MECHANICAL CLASSIFICATION*	Impact = Level 8, Cable Anchorage = Class D
ENCLOSURE PROTECTION	IK10 to IEC 62262 (20 joules) Brass & Stainless Steel only
ELECTRICAL CLASSIFICATION**	Category B (Category A when used with braid, tape or pliable wire armour cables)
INGRESS PROTECTION RATING**	IP66, IP67 & IP68****
DELUGE PROTECTION COMPLIANCE	DTS01: 91
CABLE TYPE	Steel / Served Wire Armour (SWA), Aluminium Wire Armour (AWA), Pliable Wire Armour (PWA), Steel Tape Armour (STA), Aluminium Strip Armour (ASA), Screened Flexible (EMC) Wire Braid (e.g. CY/SY), Wire Braid Armour (e.g. SWB)***
ARMOUR CLAMPING	Cone & AnyWay Universal Clamping Ring
SEAL MATERIAL	CMP SOLO LSF Halogen Free Thermoset Elastomer / RapidEx Resin Barrier
SEALING TECHNIQUE	CMP Outer Load Retention Seal and Inner RapidEx Barrier Seal
SEALING AREA(S)	Inner RapidEx Barrier Seal & Outer Sheath
CABLE GLAND MATERIAL	Electroless Nickel Plated Brass, Copper Free (<0.4%) Aluminium, Stainless Steel

\* Mechanical and Electrical Classifications applied as per IEC 62444 and EN 62444 \*\* When CMP installation accessories are used. Refer to [www.cmp-products.com](http://www.cmp-products.com) for further information. \*\*\*Where the cable is permitted by code (NEC and/or CEC). \*\*\*\* IP68 tested to a minimum depth of 30 metres for 12 hours, alternative depths / durations can be provided upon request.

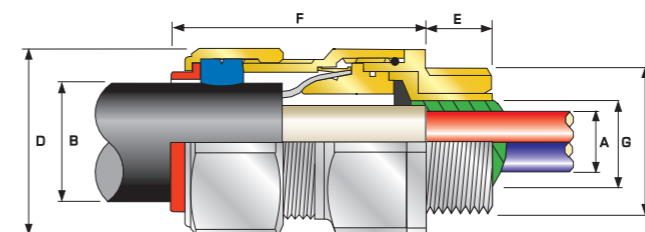

GLOBAL PRODUCT CERTIFICATION			
ATEX CERTIFICATE	CML 18ATEX1325X CML 18ATEX4317X	IECEX CERTIFICATE	IECEX CML 18.0182X
CODE OF PROTECTION	II 2G 1D, Ex db IIC Gb, Ex eb IIC Gb, Ex ta IIC Da, II 3G Ex nR IIC Gc, II M2 Ex db I Mb*, Ex eb I Mb*	CODE OF PROTECTION	Ex db IIC Gb, Ex eb IIC Gb, Ex nR IIC Gc, Ex ta IIC Da, Ex db I Mb*, Ex eb I Mb*
COMPLIANCE STANDARDS	EN 60079-0, 1, 7, 15, 31	COMPLIANCE STANDARDS	IEC 60079-0, 1, 7, 15, 31
cCSAus CERTIFICATE	2288626		
CSAus CODE OF PROTECTION**	Class I, Div. 1 and 2, Groups A, B, C and D; Class II, Div. 1 and 2, Groups E, F and G; Class III, Div. 1 and 2; Type 4X; Oil Resistant II; Class I, Zone 1 AEx d IIC Gb, AEx e IIC Gb; Class I, Zone 2 AEx nR IIC Gc; Class I, Zone 20, AEx ta IIC Da		
cCSA CODE OF PROTECTION**	Class I, Div. 1 and 2, Groups A, B, C and D; Class II, Div. 1 and 2, Groups E, F and G; Class III, Div. 1 and 2; Type 4X; Oil Resistant II; Ex d IIC Gb, Ex e IIC Gb, Ex nR IIC Gc, Ex ta IIC Da		
COMPLIANCE STANDARDS	CSA-C22.2 No 0, 18, 25, 30, 94, 174, CSA C22.2 No 60079-0, 1, 7, 15, 31; CAN/CSA-E61241-1-1 Part 11; ANSI/UL 514B Ed 5, ANSI/UL 50 Ed 11, ANSI/UL 2225 Ed 4; UL60079-0, 1, 7, 15, 31		
EAC CERTIFICATE	TC RU C-GB.AA87.B.00487	UKrSEPRO CERTIFICATE	CL19.0371X
RETIE APPROVAL NUMBER	03866	CCOE / PESO (INDIA) CERTIFICATE	P548696, P533772, P548695
INMETRO APPROVAL	TUV 12.2073X		
MARINE APPROVALS	LRS: 01/00172, DNV: TAE000000Y, ABS: 20-LD1948801-PDA, BV: 43180/A1 BV		

\* Per ATEX CML 18ATEX1325X and IECEX CML 18.0182X, aluminium alloys are not permitted in Group I mining applications. \*\* Where the cable is permitted by code (NEC and/or CEC).



COMBINED ORDERING REFERENCE			AVAILABLE ENTRY THREADS *C		NUMBER OF CORES	DIAMETER OVER CONDUCTORS *A	CABLE BEDDING DIAMETER *G	OVERALL CABLE DIAMETER *B		ARMOUR RANGE				CROSS FLATS *D'	CROSS CORNERS *D'	PROTRUSION LENGTH *F'	SHROUD	CABLE GLAND WEIGHT (kg)
SIZE	TYPE	ORDERING SUFFIX	METRIC	THREAD LENGTH *E	MAX	MAX	MAX	MIN	MAX	GROOVED CONE (X)		STEPPED CONE (W)		MAX	MAX			
20S16	PX2KREX	1RA5	M20	15.0	21	11.7	11.7	6.1	13.1	0.3	1.0	0.8	1.25	30.5	33.6	60.2	PVC06	0.24
20S	PX2KREX	1RA5	M20	15.0	21	11.7	11.7	9.5	15.9	0.3	1.0	0.8	1.25	30.5	33.6	60.2	PVC06	0.23
20	PX2KREX	1RA5	M20	15.0	21	12.6	12.9	12.5	20.9	0.4	1.0	0.8	1.25	30.5	33.6	60.36	PVC06	0.24
25S	PX2KREX	1RA5	M25	15.0	30	17.5	17.9	14.0	22.0	0.4	1.2	1.25	1.6	37.5	41.3	69.5	PVC09	0.37
25	PX2KREX	1RA5	M25	15.0	30	17.5	17.9	18.2	26.2	0.4	1.2	1.25	1.6	37.5	41.3	69.5	PVC09	0.37
32	PX2KREX	1RA5	M32	15.0	50	23.6	23.9	23.7	33.9	0.4	1.2	1.6	2.0	46.0	50.5	75.0	PVC11	0.57
40	PX2KREX	1RA5	M40	15.0	59	30.0	30.3	27.9	40.4	0.4	1.6	1.6	2.0	55.0	60.5	75.0	PVC15	0.80
50S	PX2KREX	1RA5	M50	15.0	89	36.6	36.9	35.2	46.7	0.4	1.6	2.0	2.5	60.0	66.0	77.0	PVC18	0.90
50	PX2KREX	1RA5	M50	15.0	115	41.0	41.3	40.4	53.0	0.6	1.6	2.0	2.5	70.0	77.5	77.0	PVC21	1.19
63S	PX2KREX	1RA5	M63	15.0	115	47.9	48.4	45.6	59.4	0.6	1.6	2.0	2.5	75.0	82.5	79.7	PVC23	1.39
63	PX2KREX	1RA5	M63	15.0	115	53.7	54.0	54.6	65.8	0.6	1.6	2.0	2.5	80.0	88.0	80.3	PVC25	1.41
75S	PX2KREX	1RA5	M75	15.0	140	59.9	60.2	59.0	72.0	0.6	1.6	2.0	2.5	90.0	99.0	86.8	PVC28	2.09
75	PX2KREX	1RA5	M75	15.0	140	64.3	64.6	66.7	78.4	0.6	1.6	2.5	3.0	100.0	110.0	88.3	PVC30	2.54
90	PX2KREX	1RA5	M90	20.0	140	75.3	75.6	76.2	90.3	0.8	1.6	3.15	4.0	115.0	126.5	102.1	PVC32	3.71
100	PX2KREX	1RA5	M100	20.0	200	83.6	83.9	86.1	101.4	0.8	1.6	3.15	4.0	127.0	139.7	114.0	LSF33	4.81

Dimensions are displayed in millimetres unless otherwise stated

# PXSS2KREX



**PXSS2KREX GLOBALLY APPROVED, EXPLOSIVE ATMOSPHERE RAPIDEX BARRIER CABLE GLAND**

## FOR ALL TYPES OF UNARMoured CABLES

- RapidEx liquid pour sealing system reduces installation time
- Direct and remote installation
- Superior levels of cable retention
- Displacement type environmental seal
- -60°C to +85°C
- Globally marked, cCSAus, IECEx and ATEX
- RapidEx liquid barrier resin seals around internal cable cores after removing any cable inner sheath/bedding; completely eliminating any risk of coldflow

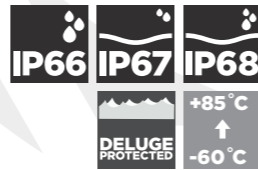
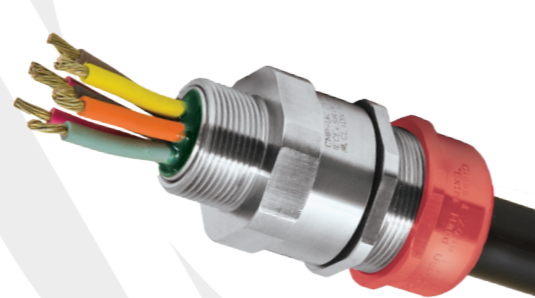

Ex db Ex eb Ex ta Ex nR

TECHNICAL CLASSIFICATION	
DESIGN SPECIFICATION	BS 6121: Part 1:1989, IEC 62444, EN 62444
MECHANICAL CLASSIFICATION*	Impact = Level 8, Cable Anchorage = Class B
ENCLOSURE PROTECTION	IK10 to IEC 62262 (20 joules) Brass & Stainless Steel only
INGRESS PROTECTION RATING**	IP66, IP67 & IP68***
DELUGE PROTECTION COMPLIANCE	DTS01: 91

CABLE TYPE	Unarmoured***
SEAL MATERIAL	CMP SOLO LSF Halogen Free Thermoset Elastomer / RapidEx Barrier Compound
SEALING TECHNIQUE	CMP Outer Displacement Seal and Inner RapidEx Barrier Seal
SEALING AREA(S)	RapidEx Resin Barrier & Cable Outer Sheath
CABLE GLAND MATERIAL	Electroless Nickel Plated Brass, Copper Free (<0.4%) Aluminium, Stainless Steel

\* Mechanical and Electrical Classifications applied as per IEC 62444 and EN 62444 \*\* When CMP installation accessories are used. Refer to www.cmp-products.com for further information. \*\*\*Where the cable is permitted by code (NEC and/or CEC) \*\*\*\* IP68 tested to a minimum depth of 30 metres for 12 hours, alternative depths / durations can be provided upon request.

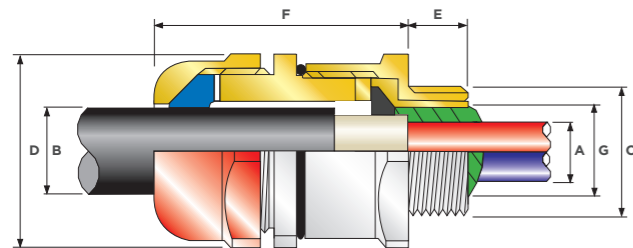

GLOBAL PRODUCT CERTIFICATION			
ATEX CERTIFICATE	CML 18ATEX1325X CML 18ATEX4317X	IECEx CERTIFICATE	IECEx CML 18.0182X
CODE OF PROTECTION	⊕ II 2G 1D, Ex db IIC Gb, Ex eb IIC Gb, Ex ta IIIC Da ⊕ II 3G Ex nR IIC Gc ⊕ I M2 Ex db I Mb*, Ex eb I Mb*	CODE OF PROTECTION	Ex d IIC Gb, Ex e IIC Gb, Ex nR IIC, Ex ta IIIC Da
COMPLIANCE STANDARDS	EN 60079-0,1,7,15,31	COMPLIANCE STANDARDS	IEC 60079-0,1,7,15,31
cCSA CERTIFICATE	2288626		
cCSA CODE OF PROTECTION**	Class I, Div 1 and Div 2, Groups A, B, C, and D; Class II, Div 1 and Div 2, Groups E, F, and G; Class III, Div 1 and Div 2; Enclosure Type 4X; Oil Resistant II: Ex d IIC Gb, Ex e IIC Gb, Ex nR IIC Gc, Ex ta IIIC Da		
CSAus CODE OF PROTECTION	Class I, Div 1 and Div 2, Groups A, B, C, and D; Class II, Div 1 and Div 2, Groups E, F, and G; Class III, Div 1 and Div 2; Enclosure Type 4X; Oil Resistance II; Class I, Zone 1, AEx d IIC Gb, Ex e IIC Gb; Class I, Zone 2, AEx nR IIC Gc; Class I, Zone 20, AEx ta IIIC Da		
COMPLIANCE STANDARDS	CSA-C22.2 No 0,18,25,30,174,94, CSA C22.2 No 60079-0,1,7,15,31; CSA C22.2 No 61241-1-1 Part II; ANSI/UL 514B Ed 5, ANSI/UL 50 Ed II, ANSI/UL 2225 Ed 4, UL60079		
EAC CERTIFICATE	TC RU C-GB.A07.B.04595/22	UkrSEPRO CERTIFICATE	CL19.0371X
RETIE APPROVAL NUMBER	03866	CCOE / PESO (INDIA) CERTIFICATE	P548696, P533772, P548695
INMETRO APPROVAL	TÜV 12.2073X		
MARINE APPROVALS	LRS: 01/00172, DNV: TAE00000Y, ABS: 20-LD1948801-PDA, BV: 43180 A1 BV		

\* Per ATEX CML 18ATEX1325X and IECEx CML 18.0182X, aluminium alloys are not permitted in Group I mining applications. \*\*Where the cable is permitted by code (NEC and/or CEC)



# A2F STAINLESS STEEL

**A2F STAINLESS STEEL GLOBALLY APPROVED, EXPLOSIVE ATMOSPHERE CABLE GLAND**

## FOR ALL TYPES OF UNARMoured CABLE

- 316L stainless steel
- Displacement type flameproof seal
- Deluge protected
- -60°C to +130°C (standard), -60°C to +180°C (ThermEx option)
- Globally marked, IECEx, ATEX and CSA

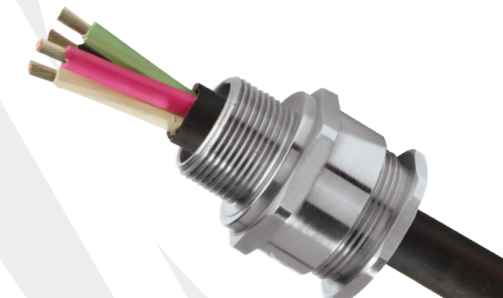

Ex db Ex eb Ex ta Ex nR

TECHNICAL DATA	
DESIGN SPECIFICATION	BS 6121: Part 1:1989, IEC 62444, EN 62444
MECHANICAL CLASSIFICATION*	Impact = Level 8, Cable Anchorage = Class B
ENCLOSURE PROTECTION	IK10 to IEC 62262 (20 joules)
INGRESS PROTECTION RATING**	IP66, IP67 & IP68***
DELUGE PROTECTION COMPLIANCE	DTS01: 91

CABLE GLAND MATERIAL	316L Stainless Steel
SEAL MATERIAL	CMP SOLO LSF Halogen Free Thermoset Elastomer
CABLE TYPE	Unarmoured & Braided (Braid terminated inside enclosure)
SEALING TECHNIQUE	CMP Displacement Seal
SEALING AREA(S)	Cable Outer Sheath

\* Mechanical and Electrical Classifications applied as per IEC 62444 and EN 62444 \*\* When CMP installation accessories are used. Refer to www.cmp-products.com for further information. \*\*\* IP68 tested to a minimum depth of 30 metres for 12 hours, alternative depths / durations can be provided upon request.

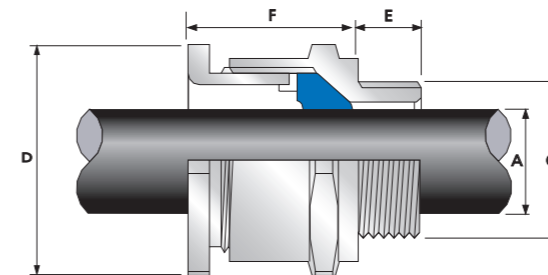

GLOBAL PRODUCT CERTIFICATION			
ATEX CERTIFICATE	CML18ATEX1321X CML18ATEX4313X	IECEx CERTIFICATE	IECEx CML 18.0179X
CODE OF PROTECTION	⊕ II 2G 1D, Ex db IIC Gb, Ex eb IIC Gb, Ex ta IIIC Da ⊕ II 3G, Ex nR IIC Gc	CODE OF PROTECTION	Ex db IIC Gb, Ex eb IIC Gb, Ex nR IIC Gc, Ex ta IIIC Da
COMPLIANCE STANDARDS	EN 60079-0,1,7,15,31	COMPLIANCE STANDARDS	IEC 60079-0,1,7,15,31
CSA CERTIFICATE	1211841		
CODE OF PROTECTION	Type 4X; Ex d IIC, Ex e II, Ex nR II		
COMPLIANCE STANDARDS	CSA C22.2 No 0,0,4,94,174; CSA C22.2 No 60079-0,1,7,15		
EAC CERTIFICATE	TC RU C-GB.AA87.B.00487	UkrSEPRO CERTIFICATE	CL19.0371X
KCS KOSHA CERTIFICATE	14-GA4B0-0251X, 13-GA4B0-0748X, 13-GA4B0-0749X, 13-GA4B0-0750X		
RETIE APPROVAL NUMBER	03866	CCOE / PESO (INDIA) CERTIFICATE	P548696, P533772, P548695
INMETRO APPROVAL	TÜV 12.0619X		
MARINE APPROVALS	LRS: 01/00172, DNV: TAE00000Y, ABS: 20-LD1948801-PDA, BV: 43180 A1 BV		



COMBINED ORDERING REFERENCE			AVAILABLE ENTRY THREADS 'C'		NUMBER OF CORES	DIAMETER OVER CONDUCTORS 'A'	CABLE BEDDING DIAMETER 'G'	OVERALL CABLE DIAMETER 'B'		ACROSS FLATS 'D'	ACROSS CORNERS 'D'	PROTRUSION LENGTH 'F'	SHROUD	CABLE GLAND WEIGHT (kg)
SIZE	TYPE	ORDERING SUFFIX	METRIC	THREAD LENGTH 'E'	MAX	MAX	MAX	MIN	MAX	MAX	MAX			
20S16	PXSS2KREX	1RA5	M20	15.0	21	8.6	8.6	3.1	8.6	30.0	33.0	53.1	PVC06	0.20
20S	PXSS2KREX	1RA5	M20	15.0	21	11.7	11.7	6.1	11.7	30.0	33.0	53.1	PVC06	0.20
20	PXSS2KREX	1RA5	M20	15.0	21	12.6	12.9	6.5	14.0	30.0	33.0	54.2	PVC06	0.20
20L	PXSS2KREX	1RA5	M20	15.0	21	12.6	12.9	10.0	15.9	30.0	33.0	54.2	PVC06	0.20
25	PXSS2KREX	1RA5	M25	15.0	30	17.5	17.9	11.1	20.0	36.0	39.6	60.0	PVC09	0.33
32	PXSS2KREX	1RA5	M32	15.0	50	23.6	23.9	17.0	26.3	41.0	45.1	61.1	PVC10	0.59
32L	PXSS2KREX	1RA5	M32	15.0	50	23.6	23.9	20.0	27.4	41.0	45.1	61.1	PVC10	0.59
40	PXSS2KREX	1RA5	M40	15.0	59	30.0	30.3	22.0	32.1	50.0	55.0	62.4	PVC13	0.56
50S	PXSS2KREX	1RA5	M50	15.0	89	36.6	36.9	29.5	38.2	55.0	60.5	65.2	PVC15	0.66
50	PXSS2KREX	1RA5	M50	15.0	115	41.0	41.3	35.6	44.0	60.0	66.0	67.6	PVC18	0.73
63S	PXSS2KREX	1RA5	M63	15.0	115	47.9	48.4	40.1	49.9	70.0	77.0	71.1	PVC21	1.07
63	PXSS2KREX	1RA5	M63	15.0	115	53.7	54.0	47.2	55.9	75.0	82.5	70.4	PVC23	1.06
75S	PXSS2KREX	1RA5	M75	15.0	140	59.9	60.2	52.8	61.9	80.0	88.0	75.3	PVC25	1.30
75	PXSS2KREX	1RA5	M75	15.0	140	64.3	64.2	59.1	67.9	85.0	93.5	74.9	PVC27	1.30
90	PXSS2KREX	1RA5	M90	20.0	140	75.3	75.6	66.6	79.4	108.0	118.8	94.8	PVC31	3.02
100	PXSS2KREX	1RA5	M100	20.0	200	85.6	85.9	76.0	90.9	123.0	135.3	86.3	LSF33	4.00

Dimensions are displayed in millimetres unless otherwise stated

COMBINED ORDERING REFERENCE			AVAILABLE ENTRY THREADS 'C'		OVERALL CABLE DIAMETER 'A'		ACROSS FLATS 'D'	ACROSS CORNERS 'D'	PROTRUSION LENGTH 'F'	SHROUD	CABLE GLAND WEIGHT (kg)
SIZE	TYPE	ORDERING SUFFIX	METRIC	THREAD LENGTH 'E'	MIN	MAX	MAX	MAX			
16	A2F	1RA4	M16	15.0	3.2	8.7	24.0	26.4	29.9	PVC04	0.06
20S16	A2F	1RA4	M20	15.0	3.2	8.7	24.0	26.4	26.0	PVC04	0.07
20S	A2F	1RA4	M20	15.0	6.1	11.7	24.0	26.4	26.0	PVC04	0.06
20	A2F	1RA4	M20	15.0	6.5	14.0	27.0	29.7	27.7	PVC05	0.07
25	A2F	1RA4	M25	15.0	11.1	20.0	36.0	39.6	35.5	PVC09	0.13
32	A2F	1RA4	M32	15.0	17.0	26.3	41.0	45.1	35.1	PVC10	0.15
40	A2F	1RA4	M40	15.0	23.5	32.2	50.0	55.0	35.1	PVC13	0.20
50S	A2F	1RA4	M50	15.0	31.0	38.2	55.0	60.5	33.0	PVC15	0.26
50	A2F	1RA4	M50	15.0	35.6	44.0	60.0	66.0	37.3	PVC18	0.27
63S	A2F	1RA4	M63	15.0	41.5	49.9	70.5	77.6	33.5	PVC21	0.43
63	A2F	1RA4	M63	15.0	47.2	55.9	75.0	82.5	36.2	PVC23	0.40
75S	A2F	1RA4	M75	15.0	54.0	61.9	84.0	92.4	34.1	PVC24	0.52
75	A2F	1RA4	M75	15.0	61.1	67.9	84.0	92.4	40.9	PVC24	0.50
90	A2F	1RA4	M90	24.0	66.6	79.9	108.0	118.8	60.3	PVC31	1.60
100	A2F	1RA4	M100	24.0	76.0	91.0	123.0	135.3	57.2	LSF33	1.78
115	A2F	1RA4	M115	24.0	86.0	97.9	133.4	146.7	67.3	LSF34	2.67
130	A2F	1RA4	M130	24.0	97.0	114.9	152.4	167.6	74.7	LSF35	3.80

Dimensions are displayed in millimetres unless otherwise stated

## TE1FU STAINLESS STEEL

## TE1FU GLOBALLY APPROVED, EXPLOSIVE ATMOSPHERE CABLE GLAND

## FOR ALL TYPES OF ARMoured CABLES

- 316L stainless steel
- Fully sequential, three step installation procedure
- Reduces installation times, cost and risk
- Direct and remote installation
- Unique compensating displacement seal system (CDS)
- Metal-to-metal armour clamping
- -60°C to +130°C
- Integral protected deluge seal
- Controlled outer load retention seal
- Unique OSTG prevents overtightening
- Globally marked, IECEx, ATEX and cCSAus
- Superior EMC performance

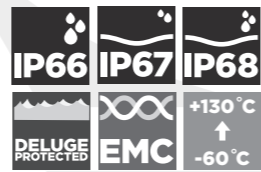

Ex db Ex eb Ex ta Ex nR

TECHNICAL DATA	
DESIGN SPECIFICATION	BS 6121-Part 1:1989, IEC 62444, EN 62444
MECHANICAL CLASSIFICATION*	Impact = Level 8, Cable Anchorage = Class D
ENCLOSURE PROTECTION	IK10 to IEC 62262 (20 joules) Brass & Stainless Steel only
ELECTRICAL CLASSIFICATIONS*	Category B (Category A when used with braid, tape or pliable wire armour cables)
INGRESS PROTECTION RATING**	IP66, IP67 & IP68***
DELUGE PROTECTION COMPLIANCE	DTS01: 91

CABLE GLAND MATERIAL	316L Stainless Steel
ARMOUR CLAMPING	Reversible Armour Cone & AnyWay Universal Clamping Ring
SEAL MATERIAL	CMP SOLO LSF Halogen Free Thermoset Elastomer
CABLE TYPE	Single Wire Armour (SWA), Aluminium Wire Armour (AWA), Pliable Wire Armour (PWA), Steel Tape Armour (STA), Aluminium Strip Armour (ASA), Screened Flexible (EMC) Wire Braid (e.g. CV/SY), Wire Braid Armour (e.g. SWB)
SEALING TECHNIQUE	CMP Inner Compensating Displacement Seal (CDS) and Outer Load Retention Seal
SEALING AREA(S)	Cable Inner Bedding & Outer Sheath

\* Mechanical and Electrical Classifications applied as per IEC 62444 and EN 62444  
 \*\* When CMP installation accessories are used. Refer to [www.cmp-products.com](http://www.cmp-products.com) for further information.  
 \*\*\* IP68 tested to a minimum depth of 30 metres for 12 hours, alternative depths / durations can be provided upon request.

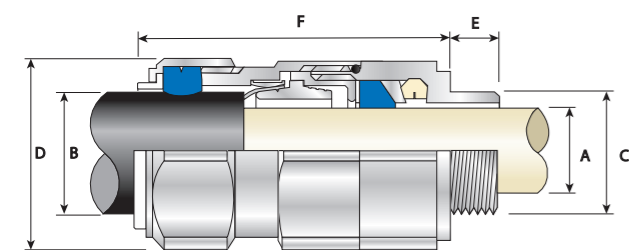

SIZE	TYPE	ORDERING SUFFIX	AVAILABLE ENTRY THREADS 'C'		OVERALL BEDDING DIAMETER 'A'		OVERALL CABLE DIAMETER 'B'		ARMOUR RANGE				ACROSS FLATS 'D'	ACROSS CORNERS 'D'	PROTRUSION LENGTH 'F'	SHROUD	CABLE GLAND WEIGHT (kg)
			METRIC	THREAD LENGTH 'E'	MIN	MAX	MIN	MAX	GROOVED CONE (X)		STEPPED CONE (W)						
					MIN	MAX	MIN	MAX	MIN	MAX	MIN	MAX					
20S16	TE1FU	1RA4	M20	15.0	3.1	8.6	6.1	13.1	0.3	1.0	0.8	1.25	24.0	26.4	24.0	PVC04	0.15
20S	TE1FU	1RA4	M20	15.0	6.1	11.6	9.5	15.9	0.3	1.0	0.8	1.25	24.0	26.4	24.0	PVC04	0.15
20	TE1FU	1RA4	M20	15.0	6.5	13.9	12.5	20.9	0.4	1.0	0.8	1.25	30.5	33.6	30.5	PVC06	0.23
25S	TE1FU	1RA4	M25	15.0	11.1	19.9	14.0	22.0	0.4	1.2	1.25	1.6	37.5	41.3	37.5	PVC09	0.34
25	TE1FU	1RA4	M25	15.0	11.1	19.9	18.2	26.2	0.4	1.2	1.25	1.6	37.5	41.3	37.5	PVC09	0.34
32	TE1FU	1RA4	M32	15.0	17.0	26.2	23.7	33.9	0.4	1.2	1.6	2.0	46.0	50.6	46.0	PVC11	0.55
40	TE1FU	1RA4	M40	15.0	22.0	32.1	27.9	40.4	0.4	1.6	1.6	2.0	55.0	60.5	55.0	PVC15	0.79
50S	TE1FU	1RA4	M50	15.0	29.5	38.1	35.2	46.7	0.4	1.6	2.0	2.5	60.0	66.0	60.0	PVC18	1.00
50	TE1FU	1RA4	M50	15.0	35.6	44.0	40.4	53.0	0.6	1.6	2.0	2.5	70.1	77.1	70.1	PVC21	1.37
63S	TE1FU	1RA4	M63	15.0	40.1	49.9	45.6	59.4	0.6	1.6	2.0	2.5	75.0	82.4	75.0	PVC23	1.50
63	TE1FU	1RA4	M63	15.0	47.2	55.9	54.6	65.8	0.6	1.6	2.0	2.5	80.0	88.0	80.0	PVC25	1.56
75S	TE1FU	1RA4	M75	15.0	52.8	61.9	59.0	72.0	0.6	1.6	2.0	2.5	90.0	99.0	90.0	PVC28	2.45
75	TE1FU	1RA4	M75	15.0	59.1	67.9	66.7	78.4	0.6	1.6	2.5	3.0	100.0	110.0	100.0	PVC30	3.15
90	TE1FU	1RA4	M90	24.0	66.6	78.6	76.2	90.3	0.8	1.6	3.15	4.0	115.0	126.5	115.0	PVC32	4.62
100	TE1FU	1RA4	M100	24.0	76.0	90.9	86.1	101.4	0.8	1.6	3.15	4.0	127.0	139.7	127.0	LSE33	4.95
115	TE1FU	1RA4	M115	24.0	86.0	97.9	101.5	110.2	0.8	1.6	3.15	4.0	138.0	151.8	138.0	LSE34	7.60
130	TE1FU	1RA4	M130	24.0	97.0	114.9	110.2	123.2	0.8	1.6	3.15	4.0	157.0	172.7	157.0	LSE35	8.73

Dimensions are displayed in millimetres unless otherwise stated

## ORDERING ACCESSORIES

When selecting and installing certified electrical equipment and components in potentially Explosive Atmospheres, it is the users responsibility to ensure that the local industry codes of practice are observed and followed, for example AS/NZS 60079-14.

To determine ordering reference please select from the tables below in the following order:

PRODUCT TYPE ▶ FORM OF PROTECTION ▶ THREAD FORM ▶ THREAD SIZE ▶ THREAD FORM (If applicable) ▶ THREAD SIZE (If applicable) ▶ MATERIAL

**EXAMPLE 1. 737DM3M25**  
 737 Adaptor - Globally Certified - M25 (M) x M20 (F) - Nickel Plated Brass

PRODUCT TYPE	FORM OF PROTECTION	MALE THREAD FORM	MALE THREAD SIZE	FEMALE THREAD FORM	FEMALE THREAD SIZE	MATERIAL
From Product Page	From Table A Below	From Table B Below	From Table C Below	From Table B Below	From Table C Below	From Table D Below
<b>737</b>	<b>D</b>	<b>M</b>	<b>3</b>	<b>M</b>	<b>2</b>	<b>5</b>

**EXAMPLE 2. 767DM25**  
 767 Stopper Plug - Globally Certified - M20 - Nickel Plated Brass

PRODUCT TYPE	FORM OF PROTECTION	MALE THREAD FORM	MALE THREAD SIZE	MATERIAL
From Product Page	From Table A Below	From Table B Below	From Table C Below	From Table D Below
<b>767</b>	<b>D</b>	<b>M</b>	<b>2</b>	<b>5</b>

TABLE A

CODE	FORM OF PROTECTION
D	Group I and Group II Globally Certified Ex d & Ex e

TABLE C

CODE	THREAD SIZE						
	METRIC 'M'	NPSM 'N'	NPT 'T'	PG 'P'	BSP 'B'	IMPERIAL 'I'	BSPT 'S'
1A	-	-	-	7	-	-	-
1	16	½"	½"	9	½"	¾"	½"
2	20	¾"	¾"	11	¾"	¾"	¾"
3	25	1"	1"	13.5	1"	1"	1"
4	32	1 ¼"	1 ¼"	16	1 ¼"	1 ¼"	1 ¼"
5	40	1 ½"	1 ½"	21	1 ½"	1 ½"	1 ½"
6	50	2"	2"	29	2"	2"	2"
7	63	2 ½"	2 ½"	36	2 ½"	2 ½"	2 ½"
8	75	3"	3"	42	3"	3"	3"
9	90	3 ½"	3 ½"	48	3 ½"	3 ½"	3 ½"
10	100	4"	4"	-	4"	4"	4"

Other thread sizes available upon request

TABLE B

CODE	THREAD FORM
M	Metric
N	NPSM
T	NPT
P	PG
B	BSP
I	E.I. (Imperial)
S	BSPT

Other variations available on request

TABLE D

CODE	MATERIAL
4	Stainless Steel 316L
5	Nickel Plated Brass

Nominal dimensions shown in this catalogue may vary due to material availability. All dimensions shown are in inches unless otherwise stated. Within the parameters of its Explosive Atmosphere certification, CMP Products reserves the right to change the design and/or dimensions of any of the products illustrated without notice. For further information please contact CMP Products.





# 747 & 757



## STOPPER PLUGS

- Available in hexagon and recessed heads
- Provides means of blanking unused cable entries
- Temporary or permanent
- Tamper-proof version available
- Nylon Ex e only version available on request only
- 60°C to +200°C (metallic versions)
- Globally marked, IECEX, ATEX, cCSAus and UL
- Wide range of thread types and sizes available



DESIGN SPECIFICATION	BS 6121:Part 1:1989
ENCLOSURE PROTECTION	IK10 to IEC 62262 (20 joules) Brass & Stainless Steel Only
ATEX CERTIFICATE	CML 18ATEX1320X
CODE OF PROTECTION	II 2G 1D, Ex db IIC Gb, Ex eb IIC Gb, Ex ta IIIC Da; I M2, Ex db I Mb, Ex eb I Mb II 2G 1D, Ex eb IIC Gb, Ex ta IIIC Da, only on Nylon version)
IECEX CERTIFICATE	IECEX CML 18.0177X
CODE OF PROTECTION	Ex db I Mb, Ex eb I Mb, Ex db IIC Gb, Ex eb IIC Gb, Ex ta IIIC Da (Ex eb IIC Gb, Ex ta IIIC Da, only on Nylon version)

747 - THREAD SIZE	747 - RECESSED	757 - THREAD SIZE	757 - HEXAGON
M16	747AM15	M16	757DM15
M20	747AM25	M20	757DM25
M25	747AM35	M25	757DM35
M32	747AM45	M32	757DM45
M40	747AM55	M40	757DM55
NPT 1/2"	747AT15	NPT 1/2"	757DT15
NPT 3/4"	747AT25	NPT 3/4"	757DT25
NPT 1"	747AT35	NPT 1"	757DT35
NPT 1 1/4"	747AT45	NPT 1 1/4"	757DT45
NPT 1 1/2"	747AT55	NPT 1 1/2"	757DT55

For material options please replace suffix "5" with "4" for 316 Grade Stainless Steel to the ordering reference

Dimensions are displayed in millimetres unless otherwise stated.

# 781



## BREATHER / DRAINS

- 781E for Ex e use
- 781D for Ex d use
- Drains equipment susceptible to moisture collection
- Enables equipment to breathe
- 60°C to +130°C (metallic versions)
- Globally marked, IECEX, ATEX and cCSAus
- NPT threads available

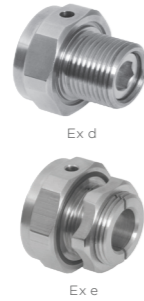

DESIGN SPECIFICATION	BS 6121:Part 1:1989
ENCLOSURE PROTECTION	IK10 to IEC 62262 (20 joules) Brass & Stainless Steel Only
ATEX CERTIFICATE	CML 18ATEX1330U
CODE OF PROTECTION	781D: II 2G 1D, Ex db IIC Gb, Ex ta IIIC Da 781E: II 2G 1D, Ex eb IIC Gb, Ex ta IIIC Da
IECEX CERTIFICATE	IECEX CML 18.0187U
CODE OF PROTECTION	781D: Ex db IIC Gb, Ex ta IIIC Da 781E: Ex eb IIC Gb, Ex ta IIIC Da

ORDERING REFERENCE 781D	ORDERING REFERENCE 781E	THREAD SIZE
781DT15	781ET15	NPT 1/2"
781DT25	781ET25	NPT 3/4"
781DM25	781EM25	M20
781DM35	781EM35	M25

For material options please replace suffix "5" with "4" for 316 Grade Stainless Steel to the ordering reference

Dimensions are displayed in millimetres unless otherwise stated.

# 767 Simtars



## STOPPER PLUGS

- Simtars marked for Queensland coal industry
- Provides means of blanking unused cable entries
- Temporary or permanent
- 60°C to +200°C (metallic versions)
- Globally marked, IECEX, ATEX, cCSAus and UL
- Wide range of thread types and sizes available



DESIGN SPECIFICATION	BS 6121:Part 1:1989
ENCLOSURE PROTECTION	IK10 to IEC 62262 (20 joules) Brass & Stainless Steel Only
ATEX CERTIFICATE	CML 18ATEX1320X
CODE OF PROTECTION	II 2G 1D, Ex db IIC Gb, Ex eb IIC Gb, Ex ta IIIC Da; I M2, Ex db I Mb, Ex eb I Mb (II 2G 1D, Ex eb IIC Gb, Ex ta IIIC Da, only on Nylon version)
IECEX CERTIFICATE	IECEX CML 18.0177X; IECEX SIM 15.0002X
CODE OF PROTECTION	Ex db I Mb, Ex eb I Mb, Ex db IIC Gb, Ex eb IIC Gb, Ex ta IIIC Da (Ex eb IIC Gb, Ex ta IIIC Da, only on Nylon version)

ORDERING REFERENCE (NICKEL PLATED BRASS)	ORDERING REFERENCE (316L STAINLESS STEEL)	THREAD SIZE	MINIMUM THREAD LENGTH	HEAD DIAMETER	PROTRUSION LENGTH	ALLEN KEY SIZE
767DM15	767DM14	M16 X 1.5	15.0	22.0	5.5	M8
767DM25	767DM24	M20 X 1.5	15.0	27.0	5.5	M10
767DM35	767DM34	M25 X 1.5	15.0	30.0	5.5	M10
767DM45	767DM44	M32 X 1.5	15.0	36.0	5.5	M10
767DM55	767DM54	M40 X 1.5	15.0	46.0	5.5	M10
767DM65	767DM64	M50 X 1.5	15.0	55.0	5.5	M10
767DM75	767DM74	M63 X 1.5	15.0	68.0	5.5	M10
767DM85	767DM84	M75 X 2.0	24.0	95.0	5.5	M14
767DM95	767DM94	M90 X 2.0	24.0	108.0	5.5	M14

For material options please replace suffix "5" with "4" for 316 Grade Stainless Steel to the ordering reference

Dimensions are displayed in millimetres unless otherwise stated.

# 717e



## Ex e NYLON STOPPER PLUGS

- Provides means of blanking unused cable entries
- Cost effective moulded design
- Universal tightening design (hex head, allen key or slotted/flat screw head)
- Temporary or permanent
- Equipment interface seal available
- 60 to +95°C



### Metallic locknut must be used for Ex e applications

INGRESS PROTECTION RATING		*MINIMUM IP68 DEPTH AND DURATION
WITHOUT ENTRY THREAD SEAL FITTED	IP66, IP67, IP68*, IP69, IP69K	1.1 metres for 16 hours**
WITH ENTRY THREAD SEAL FITTED IP66	IP66, IP67, IP68*, IP69, IP69K	30 metres for 16 hours**

\*\* Alternate depths / durations can be provided upon request.

ATEX CERTIFICATE	CML20ATEX3054X
CODE OF PROTECTION	II 2G 1D, Ex eb IIC Gb, Ex ta IIIC Da
IECEX CERTIFICATE	IECEX CML 20.0038X
CODE OF PROTECTION	Ex eb IIC Gb, Ex ta IIIC Da

COLOUR	SUFFIX	METRIC ORDERING EXAMPLE
BLACK - RAL9011	-	717EM2
BLUE - RAL5015	4	717EM24

ORDERING REFERENCE	THREAD SIZE	MINIMUM THREAD LENGTH	ACROSS FLATS	ACROSS CORNERS DIAMETER	PROTRUSION LENGTH
717EM2	M20	10.0	24.0	26.3	7.0
717EM3	M25	10.0	28.0	30.7	7.0
717EM4	M32	10.0	38.0	41.7	8.0

Dimensions shown are in millimetres unless otherwise stated.

Ordering reference shown for black metric product. For additional sizes please refer to CMP 767 above.

# 780 & PX780REX



## IN-LINE UNIONS

- Barrier and non-barrier
- RapidEx liquid pour sealing system reduces installation time
- Allows the connection of conduit or glands to equipment
- Suitable for rigid or flexible conduit
- Eliminates the need to rotate the conduit
- 60°C to +200°C (780) and -60°C to +85°C (PX780REX)
- Globally marked, IECEX, ATEX and cCSAus



DESIGN SPECIFICATION	BS 6121:Part 1:1989
ENCLOSURE PROTECTION	IK10 to IEC 62262 (20 joules) Brass & Stainless Steel only
ATEX CERTIFICATE	CML 18ATEX1327X
CODE OF PROTECTION	II 2G 1D, Ex db IIC Gb, Ex eb IIC Gb, Ex ta IIIC Da; I M2, Ex db I Mb, Ex eb I Mb
IECEX CERTIFICATE	IECEX CML 18.0190X
CODE OF PROTECTION	Ex db IIC Gb, Ex eb IIC Gb, Ex ta IIIC Da, Ex db I Mb, Ex eb I Mb

ORDERING REFERENCE 780	ORDERING REFERENCE PX780REX	MALE FORWARD THREAD	FEMALE REAR THREAD
780DM2M25	PX780REXDM2M25	M20 X 1.5	M20 X 1.5
780DM3M35	PX780REXDM3M35	M25 X 1.5	M25 X 1.5
780DM4M45	PX780REXDM4M45	M32 X 1.5	M32 X 1.5
780DM5M55	PX780REXDM5M55	M40 X 1.5	M40 X 1.5
780DT1T15	PX780REXDT1T15	NPT 1/2"	NPT 1/2"
780DT2T25	PX780REXDT2T25	NPT 3/4"	NPT 3/4"
780DT3T35	PX780REXDT3T35	NPT 1"	NPT 1"
780DT4T45	PX780REXDT4T45	NPT 1 1/4"	NPT 1 1/4"
780DT5T55	PX780REXDT5T55	NPT 1 1/2"	NPT 1 1/2"

For material options please replace suffix "5" with "4" for 316 Grade Stainless Steel to the ordering reference

Dimensions are displayed in millimetres unless otherwise stated.

# 784 & PX784REX



## 45° SWIVEL UNIONS

- RapidEx liquid pour sealing system reduces installation time
- Allows the connection of conduit or glands to equipment
- Male / male and female / female threads available
- Suitable for rigid or flexible conduit
- Eliminates the need to rotate the conduit
- Equipment interface o-ring seal available
- 60°C to +200°C (784) and -60°C to +85°C (PX784REX)
- Globally marked, IECEX, ATEX and cCSAus

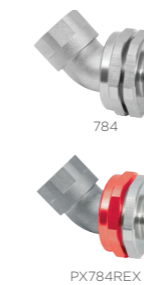

DESIGN SPECIFICATION	BS 6121:Part 1:1989
ENCLOSURE PROTECTION	IK10 to IEC 62262 (20 joules) Brass & Stainless Steel only
ATEX CERTIFICATE	CML 18ATEX1329U
CODE OF PROTECTION	II 2G 1D, Ex db IIC Gb, Ex eb IIC Gb, Ex ta IIIC Da; IP6X I M2, Ex db I Mb, Ex eb I Mb
IECEX CERTIFICATE	IECEX CML 18.0186U
CODE OF PROTECTION	Ex db IIC Gb, Ex eb IIC Gb, Ex ta IIIC Da, Ex db I Mb, Ex eb I Mb

ORDERING REFERENCE 784	ORDERING REFERENCE PX784REX	FIRST THREAD	SECOND THREAD
784DM2M25	PX784REXDM2M25	M20 X 1.5	M20 X 1.5
784DM3M35	PX784REXDM3M35	M25 X 1.5	M25 X 1.5
784DM4M45	PX784REXDM4M45	M32 X 1.5	M32 X 1.5
784DM5M55	PX784REXDM5M55	M40 X 1.5	M40 X 1.5
784DM6M65	PX784REXDM6M65	M50 X 1.5	M50 X 1.5
784DM7M75	PX784REXDM7M75	M63 X 1.5	M63 X 1.5
784DT1M25	PX784REXDT1M25	NPT 1/2"	M20 X 1.5
784DT2M35	PX784REXDT2M35	NPT 3/4"	M25 X 1.5
784DT1T15	PX784REXDT1T15	NPT 1/2"	NPT 1/2"
784DT2T25	PX784REXDT2T25	NPT 3/4"	NPT 3/4"

Dimensions are displayed in millimetres unless otherwise stated.

# 789 & PX789REX



## 90° SWIVEL UNIONS

- RapidEx liquid pour sealing system reduces installation time
- Allows the connection of conduit or glands to equipment
- Male / male and female / female threads available
- Suitable for rigid or flexible conduit
- Eliminates the need to rotate the conduit
- 60°C to +200°C (789) and -60°C to +85°C (PX789REX)
- Globally marked, IECEX, ATEX and cCSAus

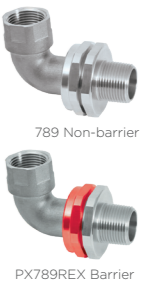

DESIGN SPECIFICATION	BS 6121:Part 1:1989
ENCLOSURE PROTECTION	IK10 to IEC 62262 (20 joules) Brass & Stainless Steel only
ATEX CERTIFICATE	CML 18ATEX1329U
CODE OF PROTECTION	II 2G 1D, Ex db IIC Gb, Ex eb IIC Gb, Ex ta IIIC Da; I M2, Ex db I Mb, Ex eb I Mb
IECEX CERTIFICATE	IECEX CML 18.0186U
CODE OF PROTECTION	Ex db IIC Gb, Ex eb IIC Gb, Ex ta IIIC Da; Ex db I Mb, Ex eb I Mb

ORDERING REFERENCE 789	ORDERING REFERENCE PX789REX	MALE FORWARD THREAD	FEMALE REAR THREAD
789DM2M25	PX789REXDM2M25	M20 X 1.5	M20 X 1.5
789DM3M35	PX789REXDM3M35	M25 X 1.5	M25 X 1.5
789DM4M45	PX789REXDM4M45	M32 X 1.5	M32 X 1.5
789DM5M55	PX789REXDM5M55	M40 X 1.5	M40 X 1.5
789DM6M65	PX789REXDM6M65	M50 X 1.5	M50 X 1.5
789DM7M75	PX789REXDM7M75	M63 X 1.5	M63 X 1.5
789DT1T15	PX789REXDT1T15	NPT 1/2"	NPT 1/2"
789DT2T25	PX789REXDT2T25	NPT 3/4"	NPT 3/4"
789DT3T35	PX789REXDT3T35	NPT 1"	NPT 1"
789DT4T45	PX789REXDT4T45	NPT 1 1/4"	NPT 1 1/4"

For material options please replace suffix "5" with "4" for 316 Grade Stainless Steel to the ordering reference

Dimensions are displayed in millimetres unless otherwise stated.

# PXRCREX



## EXPLOSIVE ATMOSPHERE

- RapidEx liquid pour sealing system reduces installation time
- Designed for rigid and flexible conduits
- Easy to install running coupler design
- Barrier type flameproof seal
- 60°C to +85°C
- Globally marked, IECEX and ATEX



DESIGN SPECIFICATION	BS 6121:Part 1:1989
ENCLOSURE PROTECTION	IK10 to IEC 62262 (20 joules) Brass & Stainless Steel only
ATEX CERTIFICATE	CML 18ATEX1325X, CML 18ATEX4317X
CODE OF PROTECTION	II 2G 1D, Ex db IIC Gb, Ex eb IIC Gb, Ex ta IIIC Da
IECEX CERTIFICATE	IECEX CML 18.0182X
CODE OF PROTECTION	Ex db IIC Gb, Ex eb IIC Gb, Ex ta IIIC Da

ORDERING REFERENCE PXRCREX	METRIC FEMALE THREAD CONNECTION
20PXRCREX1RA5	M20 X 1.5
25PXRCREX1RA5	M25 X 1.5
32PXRCREX1RA5	M32 X 1.5
40PXRCREX1RA5	M40 X 1.5
50SPXRCREX1RA5	M50 X 1.5
50PXRCREX1RA5	M50 X 1.5
63SPXRCREX1RA5	M63 X 1.5
63PXRCREX1RA5	M63 X 1.5
75SPXRCREX1RA5	M75 X 1.5
75PXRCREX1RA5	M75 X 1.5
90PXRCREX1RA5	M90 X 1.5

Dimensions are displayed in millimetres unless otherwise stated.

## ENTRY THREAD SEALING WASHERS

To maintain the ingress protection rating between the equipment and the cable gland, it may be necessary to fit an entry thread sealing washer at the equipment-to-gland entry interface. For installations it is equally essential to maintain the ingress protection integrity to which the equipment has been rated.

The need for a sealing washer will depend on the ingress protection rating, code of protection of the equipment and the type of entry holes available within that equipment. For more information refer to: [www.cmp-products.com/ingress-protection](http://www.cmp-products.com/ingress-protection).

The CMP metric entry thread sealing washers are produced in 2mm thick white nylon\* as standard which are recommended and meet the specified requirements of Shell's offshore operations (Deluge DTS01 : 91). To verify the effectiveness of the CMP nylon entry sealing washers, independent third-party tests to IEC 60529 have been successfully conducted on cable glands at IP66, IP67 and IP68 levels of protection. Documentary evidence of such tests to the highest standards can be provided.

CMP NPT entry thread sealing washers are produced in 2mm thick nylon and are colour coded green for identification purposes.

All CMP nylon entry thread sealing washers have an operating temperature range of -60°C to +130°C; for the purpose of installation, this may be restricted by, or exceeded by the operating temperature of the cable gland or cable accessory used, and care should be taken to observe the constraining temperature(s).

Should the operating temperature of the CMP nylon entry thread sealing washer not be suitable for any particular installation, please contact CMP for an alternative solution.

CMP also offers cable glands and accessories with an equipment interface O-ring seal as an alternative.

\*Please note that nylon entry thread seals are not suitable for use with the TruSeal cable gland range or 717 Series Stopper Plugs. Alternative entry thread seals are provided as standard with all TruSeal cable glands and as an optional extra with 717 Series Stopper Plugs.

ORDERING REFERENCE (METRIC)	REFERENCE DIAMETER 'A'	MINIMUM THICKNESS	EXTERNAL DIAMETER 'B'
16ETS2	M16	2.0	25.8
20ETS2	M20	2.0	28.3
25ETS2	M25	2.0	34.45
32ETS2	M32	2.0	44.2
40ETS2	M40	2.0	52.8
50ETS2	M50	2.0	64.8
63ETS2	M63	2.0	77.9
75ETS2	M75	2.0	95.9
90ETS2	M90	2.0	110.6
100ETS2	M100	2.0	120.7

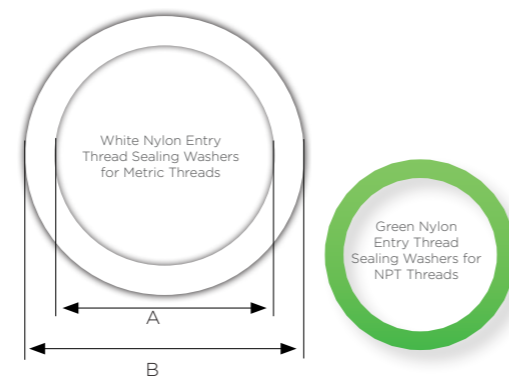

## STANDARD LOCKNUTS

Nickel Plated Brass - Recommended in securing brass cable glands and Accessories to a gland plate or into equipment.

Aluminium - Recommended when installing aluminium cable glands to prevent the galvanic corrosion which can occur when dissimilar metals are coupled together.

Please refer to ordering reference numbers (page 26), e.g. 20 LN4 for M20 stainless steel locknut, 050NPTLN4 for 1/2" NPT stainless steel locknut.

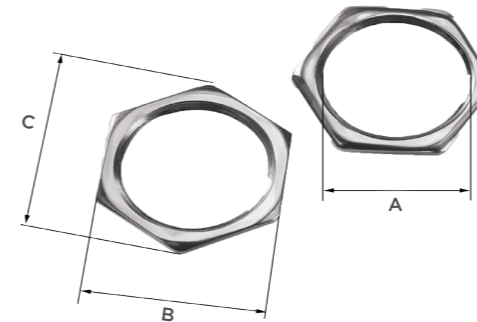

In metric thread form CMP offers brass locknuts in a choice of standard duty and heavy duty options for sizes up to and including M32. The part numbers are distinguished by an additional letter H, e.g. 20LN = standard duty, and 20HLN = heavy duty. From size M40 all brass metric locknuts are considered to be heavy duty.

ORDERING REFERENCE (METRIC)	THREAD DIAMETER 'A'	MINIMUM THICKNESS	ACROSS FLATS DIMENSION 'B'	ACROSS CORNERS DIAMETER 'C'
16LN5	M16 X 1.5	3.2	22.0	25.4
16HLN5	M16 X 1.5	5.0	22.0	25.4
20LN5	M20 X 1.5	3.2	24.0	27.7
20HLN5	M20 X 1.5	5.0	24.0	27.7
25LN5	M25 X 1.5	3.2	30.0	34.6
25HLN5	M25 X 1.5	5.0	30.0	34.6
32LN5	M32 X 1.5	3.2	36.0	41.6
32HLN5	M32 X 1.5	5.0	36.0	41.6
40LN5	M40 X 2.0	4.8	46.0	53.1
50LN5	M50 X 2.0	6.3	55.0	63.5
63LN5	M63 X 2.0	6.3	70.0	80.8
75LN5	M75 X 2.0	6.3	84.0	97.0
90LN5	M90 X 2.0	9.5	106.0	122.4
100LN5	M100 X 2.0	9.5	123.0	142.0

## TRUSEAL EMC LOCKNUTS

EMC locknuts are designed to provide good continuity between the cable gland and equipment. Through a castellated design, EMC locknuts break through any surface coatings on enclosures to provide direct contact between the enclosure and cable gland body.

- Available in brass and nickel plated brass, for alternative materials please contact CMP to enquire availability.



ORDERING REFERENCE (NICKEL PLATED BRASS)	THREAD DIAMETER 'A'	ACROSS FLATS DIMENSION 'B'	ACROSS CORNERS DIMENSION 'C'	MINIMUM THICKNESS
12EMCLNS	M12 x 1.5	15.0	16.5	4.0
16EMCLNS	M16 x 1.5	20.0	22.0	4.1
20EMCLNS	M20 x 1.5	24.0	26.4	4.3
25EMCLNS	M25 x 1.5	30.0	33.0	4.4
32EMCLNS	M32 x 1.5	36.0	39.3	4.9
40EMCLNS	M40 x 1.5	46.0	50.6	6.5
50EMCLNS	M50 x 1.5	57.0	62.7	8.0
63EMCLNS	M63 x 1.5	70.0	77.0	8.0
75EMCLNS	M75 x 1.5	80.0	87.7	8.0

## EARTH TAGS

CMP slip-on Earth tags, installed between the cable gland and equipment, provide an earth bond connection. Earth tags have been independently short circuit tested to verify their suitability under specified service conditions. A copy of the test report is available upon request and is an important factor when selecting earth tags from any manufacturer, as without this the safety of installations may be compromised.

METRIC	SHORT CIRCUIT RATINGS SYMMETRICAL FAULT CURRENT (KA) FOR 1 SECOND
20	3.06
25	4.06
32	5.40
40	7.20
50	10.40
63	10.40
75	10.40

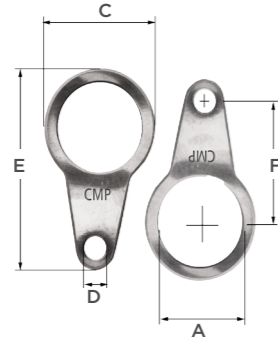

ORDERING REFERENCE (BRASS)	REFERENCE DIAMETER 'A'	MINIMUM THICKNESS	NOMINAL DIAMETER 'C'	HOLE SIZE 'D'	NOMINAL LENGTH 'E'	NOMINAL CENTRES 'F'
16ET5	M16	1.3	25.4	M6	50.4	30.2
20ET5	M20	1.3	27.1	M6	52.3	33.1
25ET5	M25	1.5	35.1	M6	59.2	35.6
32ET5	M32	1.5	45.2	M12	77.0	43.1
40ET5	M40	1.5	53.7	M13	88.7	45.4
50ET5	M50	1.5	65.2	M13	111.2	58.1
63ET5	M63	1.5	82.6	M13	128.7	66.8
75ET5	M75	1.5	95.4	M13	141.5	73.0
90ET5	M90	2.0	114.2	M13	161.0	85.0
100ET5	M100	2.0	125.0	M13	194.8	103.0

Stainless steel, aluminium and nickel plated brass earth tags are available. Please refer to ordering reference numbers, e.g. 20ET4 for M20 stainless steel earth tag, 050NPTET4 for 1/2" NPT stainless steel earth tag.

## CABLE GLAND SPANNERS

When installing cable glands and accessories it is important that the correct tools are used to carry out the installation. This includes the use of the correct cable gland spanner specifically designed to fit each individual product to minimise the potential for accidental injury caused by slippage, as can be the case with adjustable spanners or wrenches.



CABLE GLAND SIZE	A**		C**			E**				SS2K			T3CDS/TEIFU				PXSS2K			PX2K*		
	SPANNER 1	SPANNER 2	SPANNER 1	SPANNER 2	SPANNER 3	SPANNER 1	SPANNER 2	SPANNER 3	SPANNER 4	SPANNER 1	SPANNER 2	SPANNER 3	SPANNER 1	SPANNER 2	SPANNER 3	SPANNER 1	SPANNER 2	SPANNER 3	SPANNER 1	SPANNER 2	SPANNER 3	
16	SP01	SP01	-	-	-	-	-	-	-	-	-	-	-	-	-	-	-	-	-	-	-	-
20S16	SP03	SP01	SP03	SP03	SP03	-	-	-	-	SP03	SP03	SP03	SP03	SP01	SP03	SP03	-	-	-	-	-	-
20S	SP03	SP01	SP03	SP03	SP03	SP03	SP03	SP03	SP03	SP03	SP03	SP03	SP03	SP01	SP03	SP03	SP06	SP06	SP03	SP04	SP03	SP03
20	SP06	SP06	SP06	SP06	SP04	SP06	SP06	SP06	SP04	SP06	SP06	SP06	SP04	SP03	SP04	SP04	SP06	SP06	SP06	SP04	SP04	SP04
25 / 25S	SP09	SP09	SP09	SP09	SP07	SP09	SP09	SP09	SP07	SP09	SP09	SP09	SP07	SP07	SP07	SP07	SP09	SP09	SP09	SP07	SP07	SP07
32	SP12	SP12	SP13	SP13	SP13	SP12	SP12	SP13	SP13	SP12	SP12	SP12	SP13	SP07	SP13	SP13	SP12	SP12	SP12	SP13	SP13	SP13
40	SP15	SP13	SP15	SP14	SP14	SP15	SP15	SP14	SP14	SP15	SP15	SP15	SP14	SP13	SP14	SP14	SP15	SP15	SP15	SP14	SP14	SP14
50S	SP14	SP14	SP18	SP18	SP18	SP14	SP18	SP18	SP18	SP14	SP14	SP14	SP18	SP16	SP18	SP18	SP14	SP14	SP14	SP18	SP18	SP18
50	SP18	SP18	SP19	SP20	SP20	SP18	SP19	SP20	SP20	SP18	SP18	SP18	SP20	SP18	SP20	SP20	SP18	SP18	SP18	SP20	SP20	SP20
63S	SP20	SP19	SP20	SP21	SP21	SP20	SP20	SP21	SP21	SP20	SP20	SP20	SP21	SP19	SP21	SP21	SP20	SP20	SP20	SP21	SP21	SP21
63	SP21	SP20	SP22	SP22	SP22	SP21	SP39	SP22	SP22	SP21	SP21	SP21	SP22	SP20	SP22	SP22	SP21	SP21	SP21	SP22	SP22	SP22
75S	SP23	SP22	SP24	SP24	SP24	SP23	SP24	SP24	SP24	SP23	SP22	SP22	SP24	SP22	SP24	SP24	SP22	SP22	SP22	SP24	SP24	SP24
75	SP23	SP23	SP25	SP25	SP25	SP23	SP25	SP25	SP25	SP23	SP23	SP23	SP25	SP23	SP25	SP25	SP23	SP25	SP25	SP25	SP25	SP25
90	SP35	SP35	SP27	SP27	SP27	SP35	SP27	SP27	SP27	SP35	SP35	SP35	SP27	SP25	SP27	SP27	SP35	SP35	SP35	SP27	SP27	SP27
100	SP36	SP27	SP36	SP36	SP36	SP36	SP36	SP36	SP36	SP36	SP36	SP36	SP29	SP29	SP36	-	SP36	SP36	SP36	SP29	SP29	SP36
115	SP30	SP37	SP30	SP30	SP30	SP30	SP30	SP30	SP30	SP30	SP30	SP30	SP31	SP28	SP31	SP30	-	-	-	-	-	-
130	SP38	SP38	SP38	SP38	SP38	SP38	SP38	SP38	SP38	SP38	SP38	SP38	SP33	SP32	SP38	SP38	-	-	-	-	-	-

## SERRATED WASHERS

Available in stainless steel, these 'shake-proof' serrated washers can be fitted internally to the equipment before a locknut and act as an anti-vibration device to prevent the cable gland or accessory from inadvertently loosening in service.

Please refer to ordering reference numbers (page 26) for NPT options.

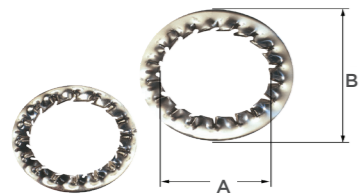

ORDERING REFERENCE (STAINLESS STEEL)	REFERENCE DIAMETER 'A'	MINIMUM THICKNESS	EXTERNAL DIAMETER 'B'
16SW4	M16	3.9	25.5
20SW4	M20	3.9	32.5
25SW4	M25	3.9	40.0
32SW4	M32	3.9	43.5
40SW4	M40	3.9	64.5
50SW4	M50	3.9	80.0
63SW4	M63	3.9	100.0
75SW4	M75	4.1	112.0
90SW4	M90	4.1	135.0
100SW4	M100	4.1	145.0

In typical installations that are not subject to vibration, a serrated washer may not be required but consideration should be given to the following statement:

Self-loosening should be avoided according to clause 6.4.1 of IEC 60079-14, this can occur through relative motion over time even without vibration, due to differential thermal effects caused as a result of either differences in temperature or differences in clamped materials.

## SHROUDS

CMP Products' shrouds minimise the risk of dirt or foreign substances gathering on the cable gland and point of cable to cable gland interface.

LSF shrouds are Low Smoke and Fume (LSF), and Phosphorus-Free to suit all CMP SOLO cable glands. Manufactured from low smoke, self-extinguishing, non-drip and halogen-free material, these shrouds are rated UL94 VO and are essential for areas where fire safety is key. CMP LSF shrouds and CMP SOLO cable glands meet the requirements of the London Underground Fire Safety Regulations and as such, they are LUL approved for use within the London Underground network.

CMP Shrouds are available in a variety of colours using the ordering references shown here. Not all colours are available in all materials, please enquire for further information.

Temperature ratings for CMP shrouds are as follows:

PVC -60°C to +90°C  
LSF -60°C to +130°C  
PCP -60°C to +100°C



SHROUD COLOUR	SHROUD MATERIAL - ORDERING EXAMPLES		
	LSF	PVC	PCP
Black	LSF06BLACK	PVC06	PCP06BLACK
Blue Grey	LSF06	PVC06GREY	-
Orange	-	PVC06OR	-

## OUTER SEAL TIGHTENING GUIDE (OSTG)



When installing cable glands it is vital that the correct tools are used to carry out the installation.

CMP Products' outer sealing tightening guide (OSTG) are available for determining the size of the cable gland needed to suit a particular cable and also the amount of spanner turns needed to close down the sealing ring without damaging the cable. OSTG's can be provided free of charge, please contact 1300 GLANDS.

## About CMP

SECURING CABLES WORLDWIDE



As a market-leading specialist designer and manufacturer of cable glands, cable cleats and accessories, CMP has been providing safe and innovative solutions to the global market for over 60 years; gaining an international reputation for quality and reliability.

Our products are developed to suit a wide range of hazardous and industrial applications; including industries such as mining, oil & gas, rail, pharmaceuticals and construction. They have been designed and rigorously tested to cover a variety of international codes, standards and approvals.

Our high-quality products are reinforced with exceptional customer service and innovative solutions; we offer on-hand technical support from our experts across the globe, from 10 different offices spread across six continents.

## Local offices

### PERTH, WA

**CMP Products Pty Ltd**

Australia

Tel: +61 8 9249 4508

E-Mail: perthoffice@cmp-products.com

### BRISBANE, QLD

**CMP Products Pty Ltd**

Australia

Tel: +61 7 3801 0301

E-Mail: qldoffice@cmp-products.com

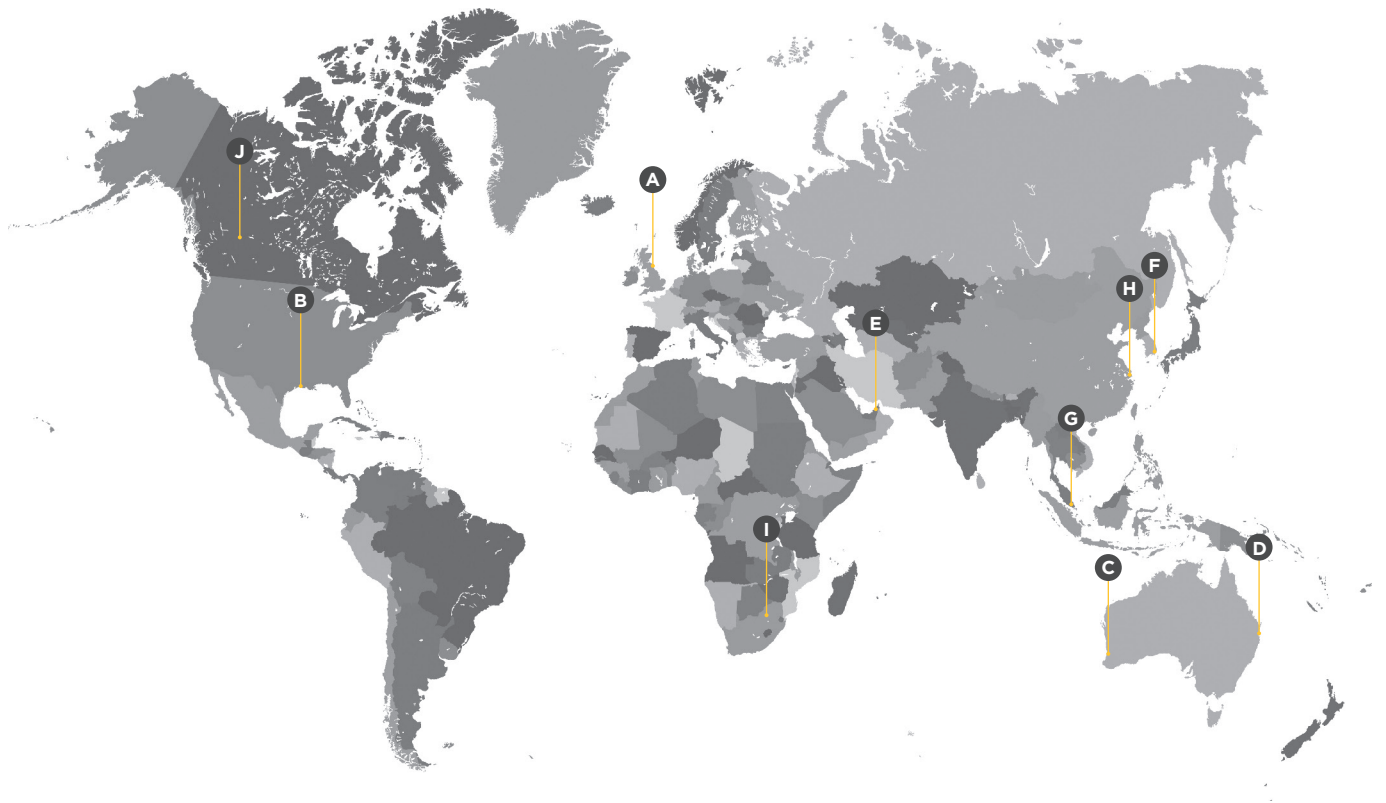

### A NEWCASTLE (Headquarters)

**CMP Products Limited**

United Kingdom

Tel: +44 (0) 191 2657411

E-Mail:

customerservices@cmp-products.com

### B HOUSTON (Texas Inc)

**CMP Products Texas Inc**

Texas, USA

Tel: +1 281 776 5201

E-Mail:

houstonoffice@cmp-products.com

### C PERTH, WA

**CMP Products Pty Ltd**

Australia

Tel: +61 8 9249 4508

E-Mail: perthoffice@cmp-products.com

### D BRISBANE, QLD

**CMP Products Pty Ltd**

Australia

Tel: +61 7 3801 0301

E-Mail: qldoffice@cmp-products.com

### E DUBAI

**CMP Products Middle East Office**

United Arab Emirates

Tel: +971 4 214 6114

E-Mail: meoffice@cmp-products.com

### F BUSAN

**CMP Products (Korea) Ltd**

South Korea

Tel: +82 51 780 5300

E-Mail: busanoffice@cmp-products.com

### G SINGAPORE

**CMP Products (S.E.A) Pte Ltd.**

Singapore

Tel: +65 6466 6180

E-Mail: seaoffice@cmp-products.com

### H SHANGHAI

**CMP Products Division**

P.R. China

Tel: +86 21 5837 9978

E-Mail:

shanghaioffice@cmp-products.com

### I JOHANNESBURG

**CMP Products**

South Africa

Tel: +27 11 266 8880

E-Mail: africaoffice@cmp-products.com

### J EDMONTON, AB

**CMP Products**

Canada

Tel: +1 281 776 5201

E-Mail: houstonoffice@cmp-products.com

[www.cmp-products.com](http://www.cmp-products.com)

SFC3001 Rev5 11/23